

XXIV. *An Account of the Measurement of a Base on Hounslow-Heath.* By Major-General William Roy, F.R.S. and A.S.

Read from April 21 to June 16, 1785.

I N T R O D U C T I O N .

ACCURATE surveys of a country are universally admitted to be works of great public utility, as affording the surest foundation for almost every kind of internal improvement in time of peace, and the best means of forming judicious plans of defence against the invasions of an enemy in time of war, in which last circumstances their importance usually becomes the most apparent. Hence it happens, that if a country has not actually been surveyed, or is but little known, a state of warfare generally produces the first improvements in its geography: for in the various movements of armies in the field, especially if the theatre of war be extensive, each individual officer has repeated opportunities of contributing, according to his situation, more or less towards its perfection; and these observations being ultimately collected, a map is sent forth into the world, considerably improved indeed, but which, being still defective, points out the necessity of something more accurate being undertaken, when times and circumstances may favour the design.

The rise and progress of the rebellion which broke out in the Highlands of Scotland in 1745, and which was finally sup-

E e e 2

pressed,

pressed, by his Royal Highness the late Duke of Cumberland, at the battle of Culloden in the following year, convinced Government of what infinite importance it would be to the State, that a country, so very inaccessible by nature, should be thoroughly explored and laid open, by establishing military posts in its inmost recesses, and carrying roads of communication to its remotest parts. With a view to the commencement of arrangements of this sort, a body of infantry was encamped at Fort Augustus in 1747, under the command of the late Lord BLAKENEY, at that time a Major-General; at which camp my much respected friend, the late Lieutenant-General WATSON, then Deputy Quarter-Master-General in North Britain, was officially employed. This officer, being himself an engineer, active and indefatigable, a zealous promoter of every useful undertaking, and the warm and steady friend of the industrious, first conceived the idea of making a map of the Highlands. As assistant Quarter-Master, it fell to my lot to begin, and afterwards to have a considerable share in, the execution of that map; which being undertaken under the auspices of the Duke of CUMBERLAND, and meant at first to be confined to the Highlands only, was nevertheless at last extended to the Lowlands; and thus made general in what related to the mainland of Scotland, the islands (excepting some lesser ones near the coast) not having been surveyed.

Although this work, which is still in manuscript, and in an unfinished state, possesses considerable merit, and perfectly answered the purpose for which it was originally intended; yet, having been carried on with instruments of the common, or even inferior kind, and the sum annually allowed for it being inadequate to the execution of so great a design in the best manner, it is rather to be considered as a magnificent military sketch,

sketch, than a very accurate map of a country. It would, however, have been completed, and many of its imperfections no doubt remedied; but the breaking out of the war of 1755 prevented both, by furnishing service of other kinds for those who had been employed upon it.

On the conclusion of the peace of 1763, it came for the first time under the consideration of Government, to make a general survey of the whole island at the public cost. Towards the execution of this work, whereof the direction was to have been committed to my charge, the map of Scotland was to have been made subservient, by extending the great triangles quite to the northern extremity of the island, and filling them in from the original map. Thus that imperfect work would have been effectually completed, and the nation would have reaped the benefit of what had been already done, at a very moderate extra-expence.

It will not be expected, that I should here attempt to assign causes for the long delay that has taken place in carrying a work of so laudable a nature into execution: suffice it to say, that a period of twelve years having elapsed, since the scheme had been first proposed, as a work that could be best executed in time of profound peace, without any thing being done in it, previous to the nation's being unfortunately involved in the American war; it was sufficiently obvious, that peace must be once more restored, before any new effort could be made for that purpose. In the mean while, as I still entertained hopes that a work which seemed to merit the attention of the public, would, at some future period, be begun, and, by gradual perseverance, ultimately brought to perfection; therefore, in the course of my ordinary military employments, wherein the very best opportunities have offered of acquiring a thorough

thorough knowledge of the country, I have not failed to observe, at least in a general way, such situations as seemed to be the best adapted for the measurement of the bases that would be necessary for the formation of the great triangles, and connecting the different serieses of them together.

The peace of 1783 being concluded, and official business having detained me in or near town during the whole of that summer, I embraced the opportunity, for my own private amusement, to measure a base of 7744.3 feet, across the fields between the Jews-Harp, near Marybone, and Black-Lane, near Pancras; as a foundation for a series of triangles, carried on at the same time, for determining the relative situations of the most remarkable steeples, and other places, in and about the Capital, with regard to each other, and the Royal Observatory at Greenwich. The principal object I had here in view (besides that it might possibly serve as a hint to the public, for the revival of the now almost forgotten scheme of 1763) was, to facilitate the comparison of the observations, made by the lovers of astronomy, within the limits of the projected survey; namely, Richmond and Harrow, on the west; and Shooter's-Hill and Wansted, on the east: and thinking, that a Paper, containing the result of these trigonometrical operations, might not prove unacceptable to the Royal Society, I was engaged in making the computations for that purpose, when, very unexpectedly, I found, that an operation of the same nature, but much more important in its object, was really in agitation. This I saw would supersede, at least for the present, my own private observations, and perhaps render them wholly useless, unless it were as a matter of mere curiosity hereafter, to see how far such as depended on a short base, and a small instrument (a quadrant of a foot radius) would agree with those

those founded on a much longer base, and angles determined by a large circular instrument, being that proposed, as the best that could be made use of in the operation now to be mentioned.

In the beginning of October, 1783, Comte D'ADHEMAR, the French Ambassador, transmitted to Mr. Fox, then one of his Majesty's principal Secretaries of State, a Memoir of M. CASSINI DE THURY, in which he sets forth the great advantage that would accrue to astronomy, by carrying a series of triangles from the neighbourhood of London to Dover, there to be connected with those already executed in France, by which combined operations the relative situations of the two most famous observatories in Europe, Greenwich and Paris, would be more accurately ascertained than they are at present*.

This Memoir the Secretary of State, by his Majesty's command, transmitted to Sir JOSEPH BANKS, the very respectable and worthy President of the Royal Society; who, about the middle of November, was pleased to communicate it to me, proposing at the same time, that I should, on the part of the Society, charge myself with the execution of the operation. To this proposition I readily assented, on being soon afterwards assured, through the proper official channels, that my undertaking it met with his Majesty's most gracious approbation.

A generous and beneficent Monarch, whose knowledge and love of the sciences are sufficiently evinced by the protection which HE constantly affords them, and under whose auspices they are seen daily to flourish, soon supplied the funds that were judged necessary. What his Majesty has been pleased to

* M. CASSINI's Memoir, with the Astronomer Royal's remarks on what is therein alledged, concerning the uncertainty of the relative situations of the two Observatories, will be given in the sequel.

give so liberally, it is our duty to manage with proper and becoming frugality, consistent with the best possible execution of the business to be done, so as to make it redound to the credit of the Nation in general, and of this Society in particular.

The operation, whereof we are now to give some account, being the first of the kind, on any extensive scale, ever undertaken in this country, naturally enough sub-divides itself into two parts. First, the choice and measurement of the base, with every possible care and attention, as the foundation of the work; secondly, the disposition of the triangles, whereby the base is to be connected with such parts of the coast of this island as are nearest to the coast of France, and the determination of their angles, by means of the best instrument that can be obtained for the purpose, from which the result or conclusion will be drawn. It is the first part only, as a subject of itself sufficiently distinct, that we are now to lay before the Society; it having been judged more advisable, to shew that no time has been lost in making reasonable progress, than to defer the account till the whole operation should be ultimately completed.

Choice of the Base. Tab. XVI.

Hounslow-Heath having always appeared to be one of the most eligible situations, for any general purpose of the sort now under consideration, because of its vicinity to the Capital and Royal Observatory at Greenwich, its great extent, and the extraordinary levelness of its surface, without any local obstructions whatever to render the measurement difficult; being likewise commodiously situated for any future operations of a similar nature, which his Majesty may please to order to be
 extended

extended from thence, in different directions, to the more remote parts of the island, it was proposed to Sir JOSEPH BANKS, that the local circumstances should be actually examined; so far, at least, as to enable us to form some judgement, of the best position of the line to be measured.

The 16th day of April, 1784, being accordingly fixed on for the purpose, and Mr. CAVENDISH and Dr. BLAGDEN accompanying the President on this occasion, we began our observations at a place called King's Harbour, at the north-west extremity of the Heath, between Cranford-Bridge and Longford; and having proceeded from thence through the narrow gorge, formed by Hanworth-Park and Hanworth-Farm, we finished at Hampton Poor-house, near the side of Bushy-Park, at the south-east extremity; the total distance, from the survey of Middlesex, being upwards of five miles.

On this inspection it was immediately perceived, that the first part of the operation, in order to facilitate the measurement, would be, the clearing from furze-bushes and ant-hills, a narrow tract along the heath, as soon as the ground should be sufficiently dry to permit the base to be accurately traced out thereon.

First tracing of the Base, and clearing of the Ground. Tab. XVI.

Chiefly with a view to the more effectual execution of the work, it was judged to be a right measure to obtain and employ soldiers, instead of country labourers, in tracing the base, clearing the ground, and assisting in the subsequent operations. For, at the same time that this was obviously the most frugal method, it was evident, that soldiers would be more attentive to orders than country labourers; and by encamping on the

spot would furnish the necessary centinels, particularly during the night, for guarding such parts of the apparatus, as it was foreseen must remain carefully untouched, in the frequent interims of discontinuing and resuming the work. Accordingly, a party of the 12th regiment of foot, consisting of a serjeant, corporal, and 10 men, were ordered to march from Windsor to Hounslow-Heath, where they encamped on the 26th of May, close by Hanworth Summer-house, to which spot the necessary tents, camp equipage, and entrenching tools, &c. had been previously sent.

Whatever might have been the particular direction given to the base considered by its extremities, from consulting the plan it will easily appear, that it must always necessarily lead through the narrow gorge of the Heath formed by Hanworth-Park and Hanworth-Farm. The first point therefore to be attended to, in tracing it out, was, that it might lead through this pass, without interfering with certain ponds, or gravel-pits full of water, which are in it. These were easily avoided by carrying the line pretty near to Hanworth Summer-house; and in directing the telescope from thence towards the south-east, it was accidentally found, that by leaving Hampton Poor-house a very little to the westward, or right, the line would coincide with a remarkable high spire, seen at the distance of eleven or twelve miles, and known afterwards to be Bansted-Church. As there could not be a better situated, or more conspicuous object than this, therefore the first or south-east section of the base, comprehended between the Summer-house and the angle of the small field adjoining to Hampton Poor-house, was immediately directed upon it; and the soldiers were the same day set to work to clear the tract, which, at a medium, was made from two to three yards in breadth. This operation

operation continued eight or ten days, owing to the lower part of the heath, between Wolfey-River and the Poor-house, being encumbered with brush-wood.

When the clearing of the first section was completed, the second, comprehended between the Summer-house and the great road leading from Staines to London, was traced out in the following manner. One of the pyramidal bell-tents (whereof two had been provided, one of twenty-five, and the other of fifteen feet in height) being placed at the station near the Summer-house, camp colours were then arranged from distance to distance, so as to be in a line with the bell-tent and Bansted spire. In like manner, the third section, comprehended between the Staines Road and King's Arbour, was traced out.

This first tracing of the base was done by means of a common telescope held in the hand only, that no time might be lost in employing the soldiers to smooth the tract which was to be measured; because the transit instrument (my own property, for which a portable stand had been for some time preparing) was not yet ready to be applied, as it afterwards was, in tracing out the base more accurately.

The camp still remained, where it was originally pitched, at the angle of Hanworth-Park, this being a very convenient position, with regard to the first and second sections; but being too remote from the third, that time might not be lost, and the men unnecessarily fatigued in marching backwards and forwards; therefore, one half of the party, under the command of the corporal, was detached to the northward, and quartered in the neighbouring villages, to clear the third section, while the serjeant, with the remainder, were occupied in smoothing the second. Owing to the extraordinary wetness of the season, this operation required more time than had been at first

imagined, not having been entirely finished before the first week of July. We shall therefore leave it going on, and in the mean time proceed to describe the instruments that were subsequently made use of in the first and second measurements.

Steel Chain. Tab. XVII.

One of the first instruments, which that able artist Mr. RAMSDEN had orders to prepare, was a steel chain, one hundred feet in length, the best that he could make. Not that it was intended, nor could it be supposed, that we should absolutely abide by the result that this chain should furnish us with, for the length of the base; but it was hoped, that an instrument of this sort might be made, which would measure distances much more accurately than any thing of that kind had ever done before: and it was considered as an object of some consequence, to endeavour to simplify, and render as easy as possible, the measurement of bases in future: an operation which, hitherto, has always been found to be tedious and troublesome, to which we may now further add, uncertainty likewise, when done with rods of deal, as will appear from the account hereafter to be given.

The construction of the chain, which is on the principles of that of a watch, will be understood from the representation of some of its chief parts, to the full size, in tab. XVII. where the first, or zero-end link, is shewn both in plan and elevation, in the state in which it was originally applied to measurement on the surface of the ground. Each link consists of three principal parts; namely, a long plate; two short ones, half the thickness of the former, with circular holes near the extremities.

extremities of each ; and two cast-steel pins, or axes, suited to the diameters of the holes, which serve to connect the adjoining links together. The holes in the short plates are made rough or jagged with a file ; so that when they have embraced the ends of two adjoining long ones, and the pins have passed through all the holes, in rivetting their extremities, they are made perfectly fast, and as it were united to the short plates ; while the embraced ends of the long ones turn freely round on the middle part of the pins.

At every tenth link the joint, just now described, has a position at right-angles to the former ; that is to say, the short plates lie here horizontally, and the pins passing through them stand vertically. Thus, there being in the whole chain two hundred cast-steel pins, one hundred and eighty lie horizontally ; and twenty, including the two by which the handles are attached, stand vertically. These cross-joints, which were chiefly intended that the chain might fold up in a smaller compass, by returning upon itself at every tenth link, are likewise useful in presenting a horizontal surface, to which small circular pieces of brass are screwed, with figures 1, 2, 3, &c. to 9, engraved on them, denoting the decimal parts of the length. Thus the middle cross-joint, or that which separates the 50th from the 51st link, is shewn in the Plate with the figure 5 upon it.

The chain, in its first construction (for we are now to point out some alterations that were afterwards made in it), was one hundred feet in length, including the two brass handles ; in the extremity of each of which there was a semi-circular hole, of the same diameter with the steel arrows successively fixed in the ground, and serving to keep the account of the number of chains, when applied to common measurement. In this its first

first mode of application it was soon discovered, as we shall have occasion to mention hereafter, how admirably the chain performed; and that, with some farther precautions, a still greater degree of exactness might be attained, by supporting it on stands, or even on planks, laid on, or but little removed from, the common surface of the earth. For this purpose, the two end-links were altered, each being now made equal to one foot, exclusive of the handles. By referring to tab. XVII. the nature of this alteration will be easily conceived. It consisted in screwing to the under side of the handles, very near the joints, two feather-edged pieces of brass*; the one denoting zero, and the other 100 feet. Over the dart at the first, a plummet with a fine silver wire being suspended, that wire, by a very simple apparatus, hereafter to be described, may be brought accurately to coincide with any point whatever of commencement: and at the second, a fine line with a knife, or other sharp instrument, being drawn on a piece of card placed there for the purpose, and changed as often as needful; or, as was likewise practised, and found to answer better, a line on a moveable slide of brass, attached to the top of the stand or plank, being brought to coincide with the feather-edge, and then fastened underneath; the extremity of the 100 feet is readily ascertained: and thus the measurement may be continued on with great accuracy to any distance at pleasure.

That the chain, in this its altered state, may still be advantageously applied to ordinary measurement on the surface of the earth, the pieces above described, having steady pins, and being fastened with screws, can be easily removed, and others,

* They were originally of brass, but are now of steel, that the edges by being harder might run less risk of being damaged.

exactly of the same length, substituted in their stead, with semi-circular holes (as represented in the Plate by dotted lines near the joint of the handle) to receive the steel arrows, then to be made use of in the manner already mentioned.

This most excellent chain seems not to have suffered any perceptible extension from the use that has hitherto been made of it. It is so accurately constructed, that when stretched out on the ground, as in common use, all the long plates lying vertically or edge-wise, if a person, laying hold of either end with both hands, gives it a flip or jerk, the motion is, in a few seconds, communicated to the other end, in a beautiful vertical serpentine line; when the person, holding that handle, receives a sudden shock, by the weight of the chain pulling him forcibly. The chain weighs about eighteen pounds, and when folded up is easily contained in a deal box, about fourteen inches long, eight inches broad, and the same in depth.

Deal Rods. Tab. XVIII.

The bases which have hitherto been measured in different countries, with the greatest appearance of care and exactness, have all, or for the most part, been done with deal rods of one kind or other, whose lengths being originally ascertained by means of some metal standard, were, in the subsequent applications of them, corrected by the same standard. Having thus had so many precedents, serving as examples to guide us in our choice, it was natural enough that we should pursue the same method in the measurement to be executed on Hounslow-Heath; taking, however, all imaginable care, that our rods should be made of the very best materials that could be procured;

cured; with this farther precaution, that by trussing them, they should be rendered perfectly inflexible, a circumstance not before attended to.

As some difficulty had been found in procuring well-seasoned Pine-wood of sufficient length, and perfectly free from knots, for the intended purpose; therefore Sir JOSEPH BANKS had early applied to the Admiralty for assistance in this respect; and forthwith obtained an order to be furnished with what we might have occasion for, from his Majesty's yard at Deptford, where an old New-England mast, and also one of Riga wood, were speedily cut up for our use.

New-England white Pine is lighter, less liable to warp, and less affected by moisture, than Riga red wood. But the New-England mast, when it came to be very minutely examined, was found to be too much wounded by shot-holes in some parts, or too much decayed or knotty in others, to afford us a sufficiency. This being the case we had recourse to the Riga wood, which was indeed extremely smooth and beautiful; and so perfectly straight-grained, that a fibre of it, when lifted up, might be drawn, like a thread, almost from one end to the other.

It had been in contemplation, to make the rods of twenty-five or thirty feet in length; and one of the former dimensions was actually constructed: but this being found to be rather too unwieldy, it was judged best to content ourselves with those of about twenty feet.

Different opinions have been entertained with regard to the best mode of applying rods in measurement; some contending that contacts, or that of butting the end of one rod against the end of the other, is the best; while others (with more probability of
being

being right) are of opinion, that the adjustment by the coincidences of lines should have the preference. The first is undoubtedly the most expeditious method; but seems at the same time to be liable to this very objectionable circumstance, that the probable errors fall all one way: whereas, in the second method, although by far the most tedious, the errors of coincidence falling sometimes on one side, and sometimes on the other, they compensate for, or destroy, each other; and therefore no error is committed.

With the view of satisfying both parties, and in order to put the matter, if possible, out of doubt, it was judged proper to construct the rods in such a manner as to admit of both methods being tried, that we might adhere to that which should be found by experience to be the best.

Three measuring rods were accordingly ordered to be made, and also a standard rod, with which the former were from time to time to be compared. Their general construction will be better conceived from the plan and elevation, and other representations of their principal parts, in tab. XVIII. than by any description, however particular, conveyed in words. It will be sufficient to say, that the stems of the three measuring rods are each twenty feet three inches in length, reckoning from the extremities of the bell-metal tipplings; very near two inches deep; and about $1\frac{1}{4}$ inch broad. Being trussed laterally and vertically, they are thereby rendered perfectly, or at least as to sense, inflexible. The standard rod could only be trussed laterally; and it is justly represented by the plan of the other rods, excepting that its stem is something stronger, and that it has two or three inches at each end of extra-length, the reasons for which differences will appear hereafter.

By referring to the Plate it will be observed, that two narrow pieces of ivory, each fastened with two small screws, are inlaid into the upper surface of the rods, within one inch and a half of the extremities of the tippings. These ivory pieces received the fine black lines cut into them when the lengths of the rods were laid off, in the manner hereafter to be mentioned, and accurately determined the intermediate distance of 20 feet, or 240 inches, the measure to be used in the application by coincidences: whereas, in that by contacts, the space comprehended between the extremities of the projecting lips of the tippings, is 243 inches.

Immediately behind each ivory piece, a cavity is formed underneath, in the middle of the stem. This receives a brass wheel, about eight-tenths of an inch in diameter, whose axis turns in the fork of a brass spring, five inches long, fastened by a screw to the under surface just before the cross feet. These springs are only of such strength as to permit the wheels to be forced up into the cavities by the weight of the rod, which, in its adjusted state, always rests entirely on the surfaces of the two stands that support its extremities. But when the rod is to be raised from the stands, then the milled-headed screws, projecting above the upper surface, and standing over the middle of the springs, being brought to act, the wheels are thereby pressed downwards, and receive the full weight of the rod, which is then easily moved backwards or forwards to its true position, either of contact or coincidence.

The cross-feet, placed about $5\frac{1}{2}$ inches from the ends of the rods, and $1\frac{1}{4}$ inch from the insertion of the trussings, are each about nine inches long, $1\frac{1}{2}$ broad, and nearly an inch in depth, having their lower surfaces level with that of the stem. By

means of these, the rods are not only kept more steady on the stands, against the common action of the wind upon the trussings; but they likewise serve as holds for the vertical and horizontal brass clamps, whereby the rods are made fast to the stands on one side or other, and in both modes of application, contacts and coincidences; as will be more fully explained hereafter, in describing the tops of the stands.

Brass Standard Scale, and method of laying off the lengths of the Deal Rods.

At the sale of the instruments of the late ingenious optician Mr. JAMES SHORT, I purchased a finely divided brass scale, of the length of 42 inches, with a VERNIER'S division of 100 at one end, and one of 50 at the other, whereby the 1000th part of an inch is very perceptible. It was originally the property of the late Mr. GRAHAM, the celebrated Watch-maker; has the name of JONATHAN SISSON engraved upon it; but is known to have been divided by the late Mr. BIRD, who then worked with SISSON.

It is sufficiently well known to this Society, that their brass standard scale, about 42 inches long, which contains on it the length of the standard yard from the Tower, that from the Exchequer, and also the French half-toise, together with the duplicate of the said scale, sent to Paris for the use of the Royal Academy of Sciences, were both made by Mr. JONATHAN SISSON, under Mr. GRAHAM'S immediate direction. Now, although there seemed to be every reason to suppose, that the scale at present in my possession, originally Mr. GRA-

HAM's property, would correspond with those above-mentioned, which he had been directed by the Royal Society, with so much care and pains, to provide; yet, that nothing of this sort might remain doubtful, it was judged right, in settling the absolute length of the base, which I measured near London in 1783, as has been mentioned in the introduction to this Paper, that the two scales should be actually compared. Having accordingly obtained an order from the President, for admission into the Society's Apartments, I went there in the afternoon of the 13th of August, and laid both scales taken out of their cases on the table of the meeting-room, with thermometers along-side of them, that they might acquire the same temperature. On the forenoon of the 15th of August the comparison was made, with the assistance of Mr. RAMSDEN, who for that purpose carried along with him his curious beam-compasses, whose micrometer-screw shews very perceptibly a motion of $\frac{1}{3000}$ th part of an inch. Thus the extent of three feet, being carefully taken from the Society's standard, and applied to my scale, it was found to reach exactly to 36 inches, the temperature being 65° . In like manner, the beam-compasses being applied to the length of the Exchequer yard, the extent was now found by the micrometer to over-reach that yard by $\frac{6}{1000}$ th, or nearly $\frac{7}{1000}$ th parts of an inch.

Having thus shewn that my scale is accurately of the same length with the Society's standard, it remains to point out the use that was made of it, for ascertaining the lengths of the deal rods, intended for the operation on Hounslow-Heath. In the first place, Mr. RAMSDEN prepared a beam-compass, sufficient to take in twenty feet, trussed in all respects like the

mea-

measuring rods, but something deeper, and fitted as usual with proper points and micrometer. The standard rod being now constructed was laid on the shop-board, strongly framed for the purpose, and nearly level. To one side of it, at the distance of about twenty feet two inches from center to center, two strong bell-metal cocks were firmly screwed. These cocks were about $2\frac{1}{4}$ inches in length, three-eighths in thickness, and rose above the stem nearly two inches, so as to be on the same plane with the surface of the measuring rods, when placed upon it.

A large plank, cut from the New-England mast, upwards of thirty feet long, nine or ten inches broad, and about three inches thick, being set edge-wise in the same room, on part of the stands now ready for the operation, was, in that position, planed perfectly smooth and straight. A silver wire being then stretched very tight, along the middle of the plank, from one end to the other, six spaces of forty inches each were marked off by the side of the wire, at which points seven brass pins, about one-tenth of an inch in diameter, were driven into the wood, and their tops polished with the stone. During the whole of this operation, and that which followed, the thermometer, lying by the side of the brass scale, continued steadily at or very near 63° .

A fine dot being now made on one of the extreme pins, and the silver wire being stretched over the dot, and as near as possible over the middle of the other pins, in which position it was made fast; the extent of forty inches, taken with the utmost care from the brass scale, was then marked off, by placing one point of the beam-compasses in the dot, and with the other describing a short faint arc on the surface of the se-

cond

cond pin. The beam being then removed, and one point placed in the intersection of the arc and wire, with the other point a dot was made on the third pin, under the middle of the wire. Upon this dot, as a center, a faint arc was next described on the same pin where the first had been traced. In this manner the six times forty inches were marked off, alternately with dots and arcs; a method found by Mr. RAMSDEN, in his practice, to be more accurate, than when dots only are made use of.

The exact length of twenty feet, thus obtained, was next taken between the points of the long beam-compasses, and transferred to the tops of the bell-metal cocks, placed, as has been already mentioned, on the side of the standard rod, in such manner as to leave more than one inch and a half of the said cocks beyond or without the lines denoting the extent of the twenty feet. This being done, the measuring rods were successively placed on the standard, and their sides applying close to the cocks, the distance of twenty feet was readily transferred from them to the inlaid ivory pieces, on which fine lines were afterwards cut, by marks accurately made for that purpose.

With regard to the adjustment of the lips of the bell-metal tippings, which extend exactly one inch and a half beyond the ivory lines, so as to make the total length of the rod 243 inches, it is to be observed, that they terminate in flat curves of $3\frac{1}{2}$ inches radius, passing through the inch and half points, to which they were cautiously ground down, that at first they might rather exceed than be defective in length. Any two of the rods, lying in the same plane, and also in the same straight line, being brought into contact with each other; if

of

of the true length, the space in that position, comprehended between the two lines on the inlaid ivory pieces, must be exactly three inches. For the purpose of this adjustment, the extent of three inches was therefore taken from the brass scale and cut upon the side of a detached piece of ivory; which being readily applied to the aforesaid intermediate space, the same was gradually reduced, by grinding the lips equally, till it exactly corresponded with that taken from the scale.

The three rods are numbered by a cypher on the surface of the metal at each end, 1.2; 3.4; 5.6; and that being the order in which they were to be applied in actual measurement, so it was likewise the order in which they were adjusted; that is to say, the rod 1.2 was adjusted with 3.4, and with 5.6; and the rod 3.4 was, in like manner, adjusted with 1.2 and 5.6.

One of these deal rods, when finished, was found to weigh twenty-four pounds. They were intended to be contained in two chests, one large and the other smaller. The large chest, which is about $2\frac{1}{2}$ feet deep, may be called a double one, because it has two lids that lift quite off, which, in turning upside down, become alternately top and bottom, having between them, but much nearer to the one than the other, a bottom that is common to both. The shallow side holds the standard rod; and the other, two of the measuring rods; which last is rendered practicable by having one of the side braces of each fixed only with screws, so as to be removed and replaced at pleasure. Thus one of the rods being laid in its place, the other is put over it in an inverted position; and both having the proper fastenings to keep them in their positions, the lid is then put on, and fixed by screws. The chest being now turned upside down, and the other lid removed, the standard is thereby

Thereby discovered resting on the common bottom, which has bands laid across it for the purpose, a few inches below what has now become the surface of the chest. It was necessary that the standard should rest thus high, both that the light might come freely upon it, and that, being supported by the deep sides of the chest, it might be prevented from twisting, for it will be remembered that it is only trussed laterally. By means of a small brass spring fixed to each end of the standard, a fine silk thread, as being less liable to accident than silver wire, is stretched along its stem, which by small wedges prepared for the purpose, and slipped in between it and the bands on which it rests, is always brought into the same position. This being done, the silk thread is turned off, so as to permit the measuring rods to be laid on the standard for comparison. With regard to the smaller chest, such a one was actually made, and sent down to the heath, towards the close of the operation with the deal rods; but from some mistake in its dimensions, it would not admit the third rod.

Stands for the Measuring Rods. Tab. XVIII. and XIX.

From the extraordinary levelness of Hounslow-Heath, the ascent from the south-east towards the north-west being little more than one foot in a thousand in the distance of five miles, it was easily seen, that the computed base-line, or that actually forming a curve parallel to the surface of the sea, at that height above it, would fall so little short of the hypotenusal distance, measured on, or parallel to, the surface of the Heath, as scarcely to deserve notice, had it not been thought necessary to

shew, how much one end of the base was really higher than the other; and to convince the world, that in an operation of this sort, where so much accuracy was expected, no pains were spared, nor the most trivial circumstances neglected.

From the trouble and uncertainty attending the frequent use of plummets, especially in windy weather, instead of measuring level or base lines, as has hitherto been customary (in which case it would have been necessary to make use of the plummet, or some such contrivance, at every step of ascent or descent) it was judged to be a better method to measure hypotenuses, and, having obtained the relative heights of the stations by the accurate application of the telescopic spirit-level, to compute the base lines. Thus it was proposed, that the length of the base on Hounslow-Heath should be obtained by measuring a line through the air, drawn parallel to the common surface from station to station, in equal distances of 200 yards or 600 feet each, as represented in the figure at the top of tab. XVIII.

For this purpose, two kinds of stands were used; one whose height was fixed, to be placed at the beginning and end of each 200 yards; and the others, whose heights were moveable, that their surfaces might be brought more easily to coincide with the line passing through the air from one fixed stand to the other. The fixed stands in their first state, represented by that towards the left-hand in the plate for the deal rods, were only two feet seven inches in height; but when the glass rods were afterwards used, they had an additional piece of ten inches fastened to the top (as in the left-hand stand of tab. XIX.) which made their total height above the Heath, including the platform on which they stood, three feet and a half. They are tripods of white deal, whose legs extend about

three feet from each other; and being braced diagonally, are mortoised at top into circles of the same sort of wood. Over this circle, a square table of about $11\frac{1}{2}$ inches is fixed, composed of oak, and mahogany at top; but both taken together do not exceed $1\frac{1}{4}$ inch in thickness.

The nature of the moveable stands, whereof there were at last no fewer than seventeen provided, will be comprehended from the representations of them towards the right-hand in tab. XVIII. and XIX. Their general construction, in what regards the part of them which is fixed, differs not from that of the others, excepting that they were of different heights, from two feet to about two feet eight inches, so as better to suit the irregularities of the ground where it might be necessary to place them. In the middle of each of these, an hexagonal wooden pipe descends, from the top to within two or three inches of the bottom, where it is joined by a brace reaching from each leg. This pipe receives the common cheese press wooden screw (having three sides screwed and three plane), to the top of which the square table is attached. It is embraced by the circular nut, or winch with four handles, whereby the table is elevated or depressed at pleasure; and being brought to its proper height, is there made perfectly fast by means of the flat-headed iron screw, which passing through one of the legs, presses an iron plate, fixed in the inside of the pipe, against one of the plane sides of the screw.

In describing the deal rods, there has already been occasion to make mention of the vertical and horizontal clamps, whereby the cross-feet are fastened to the table on the top of the stand. The nature of these tables will be best understood by consulting the two plans of them towards the right hand in tab. XVIII.; whereof one represents the two grooves fitted for the alternate reception

of the horizontal clamp, according to the side on which the rod lies that is to be moved on into coincidence; and the other shews it actually in its place, with the clamp itself detached in elevation along-side of it. Thus from the plan it may be perceived, that the first, or adjusted rod, lies towards the farther side of the table, and is there secured by the vertical clamp. The second, or moveable rod, lies on the hither side, and therefore the horizontal clamp is placed in the farther groove, where it is firmly pinched by the nut underneath. The rod has been brought to coincidence by working with the two milled-headed screws against the opposite sides of the cross foot. This apparatus, although perfectly good in theory, was found to be much too confined in its nature to answer well in practice, requiring the stands to be placed with a degree of precision, which could not be effected in the field without great loss of time; and this was the real cause, as will be seen hereafter, that the measurement by coincidences with the deal rods was given up, and that by contacts adhered to.

Towards the left-hand of tab. XVIII. the plan of one of the square tables is represented with the ends of the second and third rods upon it in contact. In this operation it will be perceived, that only one cross-foot of each rod could now rest on and be clamped to the stand, the tables having been inadvertently cut too small to admit of both; and although this has the appearance of imperfection, yet no inconveniency whatever was found to result from it in practice, experience having shewn, that the clamping of either end sufficed to keep the rod steady. Along-side of the table, the vertical clamp, being that now solely made use of, is likewise represented in elevation.

On the face or exterior side of each leg of all the stands, fixed as well as moveable, a plate of brass is screwed near the bottom, with two holes in each, over a groove purposely made in the wood underneath. By means of these plates, parallelopiped leaden weights, about fourteen pounds each, having brass pins with heads suited to enter the holes, and fall down in the grooves, into a narrow-pointed part of them, are readily slipped on or off each leg. Thus every stand, exclusive of its own weight, which is about thirty-one pounds, being loaded with forty-two pounds of lead, is thereby rendered perfectly firm and steady.

A number of wedges were also prepared, and always ready to be placed under the legs; by means of which, and a spirit level laid on the table, its plane is brought to the proper position.

Notwithstanding all these precautions, it having been found, in the measurement with the deal rods, that time was lost in levelling the stands, particularly in situations where the surface happened to be more than usually uneven, or where it was of a loose or spongy nature; therefore Mr. SMEATON advised (and no man's advice is more deserving of attention), that deal platforms, standing on pickets driven into the ground, and properly levelled, should be used to receive the legs of the stands. Accordingly, for the operation with the glass rods (table XIX.) twenty such triangular platforms made of inch deal, whose sides were each three feet two inches in length, and void in the middle, were provided; as also a number of beech-pickets, about an inch and a half square, and of different lengths, from seven to twelve or fourteen inches. Three of these pickets, short or long as the situation required, being driven into the ground, till their heads (by the carpenter's

level) were brought to the proper height, the platform was laid upon them; and on that the stand itself being placed, its position was ultimately corrected by the spirit level laid on the top of the table. Each of the beech pickets had a hole bored through its top, fit to receive a piece of strong tent-line, by which, and the help of one of the camp mallets, the pickets were easily pulled up again, when the platform was to be removed to a new situation.

Boning Telescope and Rods. Tab. XVIII.

In order to trace the line of 200 yards or 600 feet through the air, from one fixed stand to the other, it was usual, in the first place, to stretch a cord extremely tight along the ground, and to divide the space into rod lengths, by small wooden pins placed close by the cord, which remained there, and accordingly marked, very nearly, the points over which the centers of the intermediate stands were to come. A piece of wood, about fourteen inches in length, and one and a half in breadth, painted white, with a narrow black line along the middle of it, being prepared for the purpose, was laid on the surface of the farther stand. The boning telescope, fourteen inches long and one and a half in diameter, with a small magnifying power, and moveable object-glasses, so as to fit it for very short distances, was then laid on the surface of the nearest stand; which, by means of wedges placed under the legs, had that side towards the farther stand so elevated or depressed, as to bring the cross wires to coincide with the black line on the painted board. Twenty-four boning rods had been originally provided; but it rarely happened, that more than eight or ten
of

of that number were used in any one station. They are of clean deal, upwards of five feet in length, one inch square, and pointed with plate iron at the bottom, so as to be easily fixed into the ground. Each rod carries a cross vane, six or seven inches in length, and three-quarters of an inch in breadth. This cross vane, being moved upwards or downwards along the rod, till its upper surface coincided with the cross wires of the telescope and black line on the painted board, its under surface then marked the height to which the surface of the stand was to be brought at that particular place. In this manner, a certain number of points, in the line passing through the air from one fixed stand to the other, being accurately obtained, it was very easy, at all the intermediate places, by the application of the eye alone to the surface of any one stand or rod, to bring the surfaces of the other stands near it into the same plane.

Cup and Tripod for preserving the point upon the ground, where the measurement was discontinued at night, and resumed next morning. Tab. XVIII.

It has been already mentioned, and, in giving the account of the rough measurement with the chain, there will be farther occasion to remark, that the base was divided into hypotenuses of 200 yards or 600 feet each, where square pickets were driven into the ground, and regularly numbered, so as to be easily referred to on any occasion. In the measurement with the rods, it was customary to finish the day's work at or near one of these stations. When the rods of twenty feet were used, the termination of a rod was, of course, always found

found to be within a few inches of the picket corresponding with the hypotenuse, as determined by the chain. But with the rods of twenty feet three inches, the day's work was always ended with a fractional rod, by suspending a plummet from some convenient part of the stem, marked for the purpose, and which consequently became the point of commencement next morning.

The brass cup, made use of on these occasions, is of the figure of an inverted truncated cone, whose mean diameter is four inches, and its depth about five, with a very small inclination in the sides. It was placed in a hole dug for it in the earth, immediately under the point of suspension of the plummet, serving only to hold the water in which it vibrated.

The nature of the tripod will be best conceived from the plan and elevation of it in tab. XVIII. It consists of two strong pieces of beech wood, mortised into each other, so as to resemble a half cross, or the letter T inverted, having three strong iron prongs, about twelve inches in length, which pass through the ends of the wood, and are fastened to it by square nuts at top. On the surface of the tripod lies a similar half cross of mahogany, moveable by means of grooves in the direction of the longest side, and fixable by its proper screws, when brought to the desired position. This mahogany half cross carries on its surface a brass ruler, moveable at right-angles to the former direction, fixable also by means of its own screws, and on whose end is cut a very fine intersection. Thus any day's operation having been finished, the tripod was placed near the cup, with its longest side parallel to the line of measurement, and its prongs driven into the ground, so as to be rendered perfectly immovable without great violence. The plummet being then suspended by a fine gilt wire, at any part

of the stem of the deal rods indifferently, but always at the fixed * or hindermost end of the glass rods, the brass ruler was advanced so near as almost to touch the wire, and there made fast. This being done, the mahogany half-cross was lastly moved backwards or forwards, in the direction of the line of measurement, until the intersection, as seen by a person lying down on the ground for the purpose, accurately coincided with the gilt wire, where it was likewise fastened by its proper screws. A tent was then pitched very near the apparatus, for the soldiers who furnished the sentinel for its security, till the measurement was resumed; and particularly to guard it from being disturbed by cattle during the night.

Wheels for terminating, in a permanent manner, the extremities of the Base. Tab. XVIII.

Before any accurate measurement could ultimately be made of the base by means of rods, in order that we might with certainty refer to the same point, on any occasion that might arise of correction or repetition of the work, it had all along been foreseen, that it would be absolutely necessary to sink deep into the ground wooden pipes, or such like things, at the extremities of the base, which could not be removed, or even disturbed, by idle or ignorant people, without very considerable labour. Mr. MYLNE, F.R.S. was accordingly requested to

* That this might be conveniently done, a moveable stand was placed, under the glass rod, about four feet from the fixed end, and its table elevated till, by bearing against the lower part of the case, it received its weight. This permitted the stand under the fixed end to be lowered and removed, to make room for the apparatus.

order two such pipes to be provided, about six feet in length each, and one foot in diameter, with a bore of four inches in the uppermost end, for the depth of two feet, and cross-arms near the lowermost end, in the stile of the common warping posts. As an improvement on this idea, Mr. MVLNE very judiciously proposed that, instead of the cross-arms, the lower ends of the pipes should pass through the nave of an old coach-wheel, and then be secured by a bolt underneath. This alteration was approved of; and the machines, thus executed, were sent soon after by water to Hampton.

The plan and section of one of these wheels, with the dished side downwards, are represented towards the left-hand in tab. XVIII. where it will be perceived, that by means of four knee-pieces, made of crooked oak, the pipe is firmly bolted to the wheel, and thereby kept at right-angles to its plane. The top of the pipe is also secured exteriorly by an iron hoop, and has a cast-iron box driven into it, whose inner diameter is four inches, answering to that of the bore. Four oak piles for each wheel were prepared to be driven into the bottoms of the pits dug for their reception, which were six feet in diameter, and the same in depth. The soil near Hampton Poor-house being of a loose sandy nature, there the piles were easily driven into the bottom, until their tops were on the same level. The flat of the fellyes of the wheel being then laid on the piles, the earth was filled in and well rammed around the pipe, quite up to the surface, with which its mouth is even. But the soil at King's Arbour, being a hard-bound gravel, the piles could not be driven into the bottom of that pit; wherefore, the flat of the wheel rests there on the gravel only.

The brass cup, formerly described, was from the first intended to be placed in the pipes, for which purpose it has two

lids; one a semi-circle, with the central point marked by a line cut on its diameter, brought into the direction of the base; with which line the gilt wire, suspended at the extremity of the first rod, was made to coincide on the commencement of the measurement. The other lid has a very small hole made in its center, through which the plummet wire is to pass, when suspended from the center of the instrument, hereafter to be made use of for the determination of the angles at the base, or in any other station whatever, where it may be necessary to bring it very accurately over a point on the surface of the ground underneath.

Rough measurement of the Base with the Chain, and determination of the relative heights of the Stations by means of the Telescopic Spirit Level. Tab. XVI. and XVII.

Having in the preceding description of the various instruments, originally provided for the measurement of the base, fully explained their constructions, uses, and modes of application; and having thereby anticipated, in a great degree, what must otherwise have been said to make them understood in any account, blended with that of the execution; little more now remains to be given than the journal of our proceedings from day to day, and the ultimate result of the operation.

After a very tedious delay, Mr. RAMSDEN having at last produced his hundred-feet chain, with the portable transit instrument; and having lent us an excellent telescopic spirit level, for determining the relative heights; two sections of the base being likewise cleared by the soldiers, and some progress made in

the third, we found ourselves, on the 16th of June, in readiness to begin the rough measurement.

Lieut. Colonel CALDERWOOD, of his Majesty's Horse-Guards, F.R.S. had, from the beginning, been so good as to promise his assistance in the operation. Lieut. Colonel PRINGLE too, of the Corps of Engineers, obligingly became a volunteer on the occasion; as did also Mr. LLOYD, F.R.S. a few days afterwards; while Ensign REYNOLDS, of the 34th regiment, who had for some time past been employed in surveying the environs of the Heath, continued that work with such spare hands as could be afforded him for that purpose; and it is to the plan (tab. XVI.) done by that officer, that it will be necessary to refer in any thing regarding locality, in what has hitherto been said, as well as in the subsequent relation.

The lower end of the base had for some time past been distinguished by a St. George's flag fixed to the top of a fir spar, thirty-five feet in height; and one of the signal bell-tents still remained at the station near the summer-house. A rope of 200 yards being made very fast by a strong iron picket, driven into the ground at the bottom of the flag-staff, the other end was carried on along the base, and placed at the bottom of a camp-colour, in a line with the bell-tent. The rope being wound around a strong iron reel, prepared for the purpose, was thereby stretched extremely tight, a person occasionally lifting it up in the middle, or at other places, and letting it drop again, so as to bring the whole into the same straight line. Five persons were necessary for the proper management of the chain; two at each end for its adjustment there, and one towards the middle, to lay it close to the rope, or to bear it up in any particular place, where the circumstances of the ground rendered such precautions useful. The zero or rear end of the chain

I i i 2

being

being strained back so as to coincide with the point of commencement, a steel arrow was placed as erect as possible in the semi-circular cavity of the brass handle at the other end. The chain being then drawn on, till the cavity in the rear handle could be applied to the first arrow, a second was then placed in that of the front handle, and so on until six chain lengths were thus measured off; which terminating the first hypotenuse, a beech picket, something more than an inch square, and about seven in length, with N^o 1. cut upon it, was driven into the ground, till its head was nearly level with the surface. It is however to be remarked, that the sixth arrow of each hypotenuse was constantly left in the ground till the first of the succeeding one was placed, to avoid the error that would have otherwise arisen in applying the rear end of the chain to the picket instead of the arrow.

In this manner we proceeded on the 16th of June, and in the space of about three hours and a half, completed the first measurement of the south-east section of the base, comprehending the thirteen hypotenuses between the flag-staff and station near Hanworth Summer-house, the distance being 78 chains or 7800 feet, making 2600 yards; and the mean temperature of the air being 63°.

On the subsequent day this section was re-measured with equal care, when the total extent fell short of the thirteenth picket only five inches. And here it is to be observed, that a considerable part of this difference probably arose from the stretching of the chain across Wolfey River, at the same time that the irregularities of the ground are greater in this than in either of the other two sections. The mean heat of this day was 65°.

The

The operation with the chain was suspended during the 18th and 19th of June, those days having been employed in settling certain matters with Mr. RAMSDEN relative to the deal rods, as well as to give time for the making of a holdfast for the rear end of the chain, invented by Lieut. Colonel PRINGLE. This machine, whereof the plan at large is represented by dotted lines at the handle of the chain, as it is in small by the two elevations adjoining in tab. XVII. consists of a semi-circular iron plate, from the bottom of which projects two double and one single prong. In the middle, between the two double prongs, a semi-circular cavity is formed, fitted to receive the steel arrow on one side, while that in the brass receives it on the other. In a socket in the middle, a strong wooden handle, resembling that of a spade, is placed. Thus the rear handle of the chain being applied to the arrow, the holdfast embraces with its double prongs the straight part of the brass, and in that position, being forced into the ground by the action of a man at the handle, the rear end of the chain is thereby kept so firm as to be immoveable by the efforts of the two men at the other end, in stretching it to its true position, for the front arrow.

On Monday, the 21st of June, the operations were resumed, by measuring twice with the chain (forwards and again backwards) the thirteen hypotenuses comprehended in the second section of the base, between Hanworth Summer-house and the north-west bank of the great road (an old Roman way) leading from Staines to London. This being the smoothest part of the Heath, and the holdfast being now applied, the two measurements differed only one inch and a half in the distance of 7800 feet. This instance of accuracy is alone sufficient

ficient to prove the great excellence of the chain, although another will be given hereafter still more surprising.

On the same day that the second section of the base was measured, the levels of that and the first were taken. The operation of levelling is so universally known, as to render any detail of it unnecessary. It will be sufficient to say, that the spirit level made use of on this occasion was a very good one, about eighteen inches in length, and could at all times be very readily and accurately adjusted by inversion in its Y's. The tops of the pickets, marking the hypothensusal distances, were the points on which the levelling rods were placed on each side of the level; which being inverted at the intermediate picket, points equi-distant from the center of the earth were thereby obtained, at the cross vanes of the levelling rods, and no correction for curvature or refraction necessary. It will be readily understood, that the relative heights of the pickets were found by measuring their distances from the centers of the cross vanes and axis of the telescope respectively.

The six first columns towards the left-hand of the first or general table subjoined to this Paper, shew distinctly every thing relating to the levels of the whole base, those of the third section having been determined on the 22d of June. By examining the table it will be seen, that the ascent on the first section is 10.555 feet,

on the second	8.580
and on the third	12.130

Total	31.265 feet, be-
-------	------------------

tween the lower extremity at Hampton Poor-house, and the higher near King's-Arbour.

The computed numbers in the seventh column are the reductions * depending on the aforefaid heights, or the differences between the hypotenusal distances of 600 feet each and the reduced base distances. With regard to the remaining columns of the table, or those towards the right-hand, they will be severally spoken to hereafter, in taking into consideration the expansion of metals, as determined with great accuracy by the experiments with the pyrometer.

Hitherto no use had been made of the transit instrument: for, in order that it might be applied to advantage, there was a necessity for laying the wheel into the ground at the lower end of the base, and so to modify the St. George's flag-staff that, being placed in the pipe, it might be steadily supported by braces in a true vertical position; which we found, from experience, could not be effected by ropes only.

The wheel being accordingly laid in its place, and the other precautions taken for securing the flag-staff, which was likewise painted white, that it might be more distinctly seen from

* The reduction in the seventh column, I have computed by the difference between the square of the hypotenuse, actually measured, and the square of the height found by the level; and Lieut. Colonel CALDERWOOD has done the same thing by a much shorter method. Thus, in the annexed figure, CE being the hypotenuse of 600 feet, DE the perpendicular height obtained by levelling, DB the reduction required, or the difference between the hypotenuse and true base; then, substituting the chord BE in-

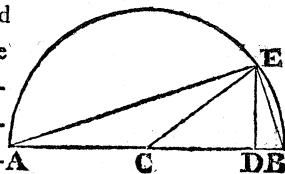

stead of DE, the following analogy is obtained; AB : BE :: BE : DB; consequently, $\frac{BE^2}{AB} = DB$: that is, the square of the perpendicular height being divided by double the distance, or 1200 feet, the quotient is equal to DB the reduction, without sensible error. For if DE were four feet, the greatest perpendicular height in the base, BE the chord would only exceed it $\frac{1}{100000}$, which would not be more than $\frac{1}{4000}$ part of an inch. The difference between the results, by the two modes of computation, is so trifling as not to deserve notice.

the

the farther extremity; on the 22d of June, the transit instrument was adjusted over the thirteenth picket at Hanworth Summer-house, while directed upon the flag-staff. But it being now found, that the vertical plane passing through the flag-staff fell to the eastward of the center of Bansted Spire, therefore the transit was gradually moved to the eastward, until by repeated trials the three points were perceived to be in the same vertical plane, when the picket was moved, and re-placed exactly under the axis of the telescope, a few inches from its first position. The same operation was repeated at the twenty-sixth station, on the farther bank of the Staines Road; and, lastly, at the forty-sixth, forming the north-west extremity of the base; where a pit was immediately dug for the wheel, which was placed therein, without however filling in the earth for the present, that being deferred till near the completion of the measurement with the deal rods. Thus the two extremities, and two intermediate points of the base, being accurately placed, by the help of the transit instrument, in the same vertical plane with Bansted Spire, it was easily seen, that by arranging camp colours in the intervals at any time, all the other points might be brought so nearly to coincide with these first, as not to occasion, by deviation, any sensible error in the measurement afterwards to be made. This application of the transit shewed us, however, that some labour had been lost by not using it sooner: for at the Staines Road, the tract cleared by the soldiers deviated about two feet and a half too much to the westward for the true line; and at King's Arbour it was twice as much; so that we were now obliged to widen the cleared tract, by adding to the eastern side of it.

On the same day that the chief points in the base were fixed by means of the transit, and the levels of the third section

taken

taken as before-mentioned, the rough measurement of that section with the chain was completed, and found to contain nineteen hypthenusal distances of 600 feet each, and one of 404.55, making in the whole 11804.55 feet, between the twenty-sixth station at the Staines Road and the center of the pipe near King's Arbour, the mean temperature being $62^{\circ}\frac{1}{2}$. Here it is to be observed, that this last section was only measured once with the chain, the tract not being yet sufficiently cleared to admit of its being done to the best advantage; and, when completed, it was judged to be better to proceed directly in the operation with the rods, than to lose time in the usual repetition, since the merits of the chain, in this way of applying it, were already sufficiently well established; and any future tests to which it was to be put were proposed to be of a more rigid nature.

When the length of the chain, in its original state, was ascertained by the dots on the brass pins in the New-England plank, it was found, in the then temperature of 74° , to exceed the 100 feet by near one quarter of an inch, or 0.245 inch. Therefore, in the temperature of 63° , being that in which the lengths of the deal rods were laid off, and differing very little from what was likewise the mean heat of the air, when applied upon the Heath, the chain, according to the experiments on the expansion of the very same steel, would exceed the 100 feet by 0.161 inch, or 0.0134 foot. Hence the sum of the three sections of the base, 274 chains, being multiplied by 0.0134 foot, we shall have 3.67 feet for the equation of the chain + 4.55 feet, to be added to its length, which will then become 27408.22 feet from the center of one pipe to the center of the other: and this would have been the true length of the base, as given by the rough measurement with the

chain, if the surface had been one uniform inclined plane throughout its whole extent. But, although the ascent of Hounslow-Heath is so small, and so gradual, as to occasion little more than half an inch of reduction, from the 46 hypotenusal to the 46 base distances, into which it is divided, as may be seen by referring to the table; yet each of these hypotenuses containing again many other small irregularities, all of which affect the measurement by the chain, in proportion to their number and height, in every space of 600 feet, their united effects, including the lateral deviations from the true line in measuring, do somewhat more than compensate for the extra-length of the chain, as will be seen hereafter in comparing the length of the base just now obtained with that given by the rods.

The weather, which during the greater part of June had been wet, became still worse towards the end of the month and first week of July; so much so, that even if the deal rods had been ready they could not have been used with advantage. The soldiers, nevertheless, were not idle, being, when the weather would permit, partly employed in clearing the Heath, and partly in assisting Mr. REYNOLDS in the survey, towards the perfecting of which many chief points were fixed by means of my astronomical quadrant, placed for that purpose at several different stations of the base. At this time too (July 8th) I levelled from the lower end of the base to the surface of the Thames at Hampton, and found the descent to be 36.18 feet.

Measurement of the Base with the Deal Rods.
Tab. XVI. and XVIII.

Such extraordinary care and pains had been bestowed in the construction of the deal rods, in order to render them the best which had ever been made, that, although begun early in June, they were not completely finished before the 15th of July. They were brought that afternoon by Mr. RAMSDEN, together with the various parts of the apparatus necessary for their application in the field, to the camp now moved from Hanworth Summer-house to the intersection of the base with Wolfey River; whence they were transported, early next morning, to the pipe near Hampton Poor-house, where we were met by Sir JOSEPH BANKS, accompanied by Mess. BLAGDEN, CAVENDISH, LLOYD, and SMEATON, all ready to lend their assistance in the subsequent mensuration.

Before I proceed farther, I think it here incumbent upon me very gratefully to remark, that the respectable and very worthy President of the Royal Society, ever zealous in the cause of science, and who had repeatedly visited the heath, to offer aid, if such had been necessary, while the first and rougher part of the operations were going on; now, that others of a more delicate nature were to commence, and where it was of importance, that those entrusted with the execution should meet with as few, and as short, interruptions as possible, not only gave his attendance from morning to night in the field, during the whole progress of the work; but also, with that liberality of mind which distinguishes all his actions, ordered his tents to be continually pitched near at hand, where his immediate

guests, and the numerous visitors whom curiosity drew to the spot, met with the most hospitable supply of every necessary and even elegant refreshment. It will easily be imagined, how greatly this tended to expedite the work, and how much more comfortable and pleasant it rendered the labour to all who obligingly took part in it; but more especially to him, who, being a volunteer in it at first, considered himself as bound to persevere in his best endeavours to bring it to a successful conclusion.

From the description that has been given of the deal rods, it will be remembered, that they are fitted to be applied in measuring, either by the coincidences of lines, inlaid one inch and a half from each extremity, or by the contacts of the spherical lips of the bell-metal with which they are tipped. The first, seeming to be the most accurate, although the most tedious method, was that by which we proposed to set out.

The flag-staff having been previously removed from the pipe, and the brass cup filled with water put in its stead, all the necessary precautions being likewise taken for preserving the line of direction, horizontally, by the rope stretched along the first hypotenuse, and vertically, by means of the boning rods; the first ivory line on the first rod was brought by the plummet to coincide with the center of the cup, in which position, being clamped, it accurately marked the commencement of the base. The second rod being now applied to the first, and moved up by the apparatus formerly described (tab. XVIII.) till its line coincided with that on the first; and, in like manner, the third rod being applied on the alternate side of the second, moved up and clamped as the rest; thus the exact distance of sixty feet was ascertained, care being always taken, that the first adjustments were not disturbed, while the subsequent

subsequent ones were forming. The clamps fastening the first rod to its stands being then detached, it was carried by two men and laid on the alternate side of the third; and so on in succession, until fifteen rod lengths were measured off, being the half of the first hypotenuse.

The time consumed in measuring this short distance of 300 feet was not less than five hours; owing, as has been formerly mentioned, to the confined nature of the apparatus for moving the rods on into coincidence, which required such nicety in placing the stands, as could not be effected until after several repeated unsuccessful trials. All the executive people were therefore of opinion, that it would be proper to discontinue this mode of measurement, at least until a more convenient apparatus could be thought of for the purpose; and that, in the mean time, we should proceed by the method of contacts, as the only alternative we could for the present adopt*.

The rods being accordingly placed in contact with each other, we soon made greater progress, finishing the operations of the day at the middle of the fourth hypotenuse, where the tripod, with its guard, was placed, to preserve the point of commencement for the ensuing morning.

* Although I acquiesced in the change thus become necessary, yet it was with much reluctance, because it left undecided the contested point, with regard to coincidences and contacts. If we could have proceeded with the coincident rods till eighty-one lengths were measured off, and then measured back the same space by placing eighty rods in contact, the point would have been clearly settled. For if the termination of the eightieth rod agreed exactly with the point of departure, contacts being the most expeditious would have been judged the best method. On the contrary, if the eightieth rod fell short of reaching the point of departure, there could have been no doubt, that the difference must have arisen from butting one rod against the other, whereby a certain small proportion of each rod came to be lost in the account, by being measured twice over.

The measuring rods, when put into the chest in London, had been compared and found to agree with the standard. The comparison was not repeated on the 16th; but this being done on the 17th, at 7 h. A.M. under the oil-cloth canopy at the camp, they were found at a medium to exceed the standard by one-fiftieth of an inch, the temperature then being 62°. After the comparison they were carried to the place of the tripod, when the operation was resumed by bringing, with the help of the plummet, the same point of the rod with which we had left off work, to coincide with the intersection on the brass ruler. The measurement of this day was closed at the end of the tenth hypotenuse, when the rods being carried back to camp, were compared, and found accurately to agree with the standard.

A considerable fall in the barometer, between the evening of the 17th and the morning of the 19th, portended rain. Nevertheless, all parties repaired to the place of rendezvous, which was appointed at the lower end of the base, in order to re-measure the two first hypotenuses, by placing all the rods in contact, which on the 16th had been done partly one way and partly the other. The operation being according repeated with great care, the point of the sixtieth rod, which formerly corresponded to the center of the second picket, was now found to be pushed forward exactly forty-five inches, answerable to the deficiency on the fifteen coincident rods, with which the mensuration was begun. It now began to rain, therefore the rods were carried back to camp, and being severally compared, they were found to exceed the standard each by one-thirtieth of an inch, occasioned by the extraordinary humidity of the air. A heavy rain ensued; and what made this much more regretted by all was, that in the forenoon their Majesties graciously condescended to honour the camp with their presence, and con-

tinued

tinued there some time; but the weather becoming rather worse, it was utterly impossible to shew their Majesties the nature of the operation, by any progress that could at that time be made in the work.

After a continuance of unfavourable weather for several days, the operations were resumed at 9 h. A.M. of the 23d, when the rods being compared were found still to exceed the standard by one-thirtieth of an inch, and the temperature now was 61°. Here it is to be observed, that in our progress forward, an accurate register had been all along kept of that point of each rod corresponding to the center of the hypotenusal pickets, by noting its distance from either end, whereby the error of the chain at each station was readily discovered, at the same time that the revolutions of the three rods served to keep the account of the total measurement. In order, therefore, that this method might be distinctly adhered to, it was judged proper to push on the rod that lay over the tripod at N° 10. exactly forty-five inches, to make good the deficiency of the first fifteen coincident rods, and that the account might be kept from the lower end of the base in entire rods of 243, and complete revolutions of 729 inches each. This being done, the rest were placed in the ordinary succession; and we finished the business of the day at the eighteenth station, where the rods being compared at 6 h. P.M. their mean length was found to exceed that of the standard $\frac{1}{67}$ th part of an inch, the temperature then being 54°.

On Saturday the 24th of July, the rods were three times compared; at 7 h. 30' A.M., 11 h. 15' A.M., and 5 h. 45' P.M. Their mean excess above the standard was found to be one-thirtieth of an inch, and the mean heat 64°. In the course of the day, the measurement was continued from the eighteenth to the

the twenty-seventh station, or first of the third section of the base, where the tripod was placed as usual; and there it remained untouched, on account of bad weather, till Monday the 2d of August.

Considering how much time and labour had been bestowed in obtaining what we certainly had every reason to conclude were the best deal rods that ever were made, it was no small disappointment now to find, that they were so liable to lengthen and shorten by the humid and dry states of the atmosphere, as to leave us no hopes of being able, by their means, to determine the length of the base to that degree of precision we had all along aimed at. But since more than one-half of it was already measured, it was judged proper to proceed with them in their present state, and then to have them carefully painted or varnished, before they should be farther used.

The unfavourableness of the season, and delays in obtaining the instruments, had already been the causes of protracting the operations on Hounslow-Heath greatly beyond what was at first expected; and the failure of the deal rods gave no immediate prospect of their being speedily brought to a conclusion. On revolving in my own mind the different alternatives we might ultimately be obliged to have recourse to, metal rods of some kind or other, whose expansion could always be determined by experiment, seemed to promise a result that might be safely relied on. Cast iron was what I had thoughts of proposing, knowing from an experiment which I had made myself, that it expanded less than steel. The cumbersome-ness of its weight appeared indeed objectionable; but that inconvenience was either to be submitted to, or one of another kind, namely, the reduction of the length, which was always, if possible, to be avoided.

At this time Lieut. Colonel CALDERWOOD could not conveniently lend us his assistance in the field; but he visited us occasionally, and on one of these visits proposed to me, that glass rods should be made use of instead of deal; putting me in mind of another experiment * that I had made, which seemed to shew that solid glass rods expanded less than tubes. This proposition the Lieutenant-Colonel, before he came to the heath, had made to Mr. RAMSDEN, who appeared averse from making the trial, because of the great length of the rods, and the brittleness of the material. Nevertheless, it being sufficiently obvious, that glass rods or tubes of the full length, or something approaching towards it, would be much sooner provided than any metal rods whatever, and the saving of time being a point of consequence; Lieut. Colonel CALDERWOOD was accordingly requested to make the trial at the glass-house, as soon as possible after his return to town. Next day he succeeded in getting a fine tube drawn, eighteen feet long, and about one inch in diameter; and there seemed to be no longer any doubt, that those of the proper length might be obtained. It was found, that solid glass rods of such extraordinary dimensions could not be had, it being impossible to take at once a sufficient

* The experiment here alluded to was made with Mr. CUMMING's pyrometer, which from its construction did not admit of a very accurate estimation of the heat communicated to the standard bar, the rod, and tube respectively. Either, therefore, the natures of the glass rod and tube, made use of at that time, must have been very different, to cause the difference of expansion; or some circumstance in the instrument unattended to had occasioned the fallacious appearance: for it will be found, from the experiments hereafter to be given in detail, that a solid glass pendulum rod expands fully as much as, nay in this particular instance even more than a tube; but different glasses, having different specific gravities, will no doubt be susceptible of different degrees of expansibility.

quantity of the melted metal on the irons, made use of for drawing them at the glass-house.

The week of rainy weather, which ended the month of July, occasioning, as has been said, a total suspension of the operations on the heath, was employed in procuring a sufficient number of glass tubes (one whereof was not less than twenty-six feet long) and regulating with Mr. RAMSDEN every thing concerning their construction into measuring rods. The description of them we shall however defer until the time of their application in the field, after having finished the operation with those of deal.

On Monday the 2d of August, the operations on the heath were resumed at 8 h. 30' A.M. by comparing the rods with the standard, which they were found to exceed by one-fortieth of an inch, the temperature then being 66°. The forward end of the rod now placed over the tripod at N° 27, completing the 800th length, reckoned from the lower end of the base by rods of 243 inches each; and these being equal to 810 rods of 240 inches; it was judged proper to mark a point upon the ground corresponding to this forward end, that it might be referred to in returning back with the measurement by the glass rods. This was done by sinking two small pickets into the ground, about a foot asunder, one on each side of the base, and at right angles to it. A silk thread being then stretched over the tops of the pickets, and gently moved on till it touched the silver wire suspended from the end of the rod, fine notches were then made with a pen-knife in the tops of the pickets, whereby the thread could be replaced in the same situation; which being done, the pickets were covered over with earth. In the course of this day nine hypotenuses were measured; and at 7 h. P.M. the tripod was placed at the thirty-sixth

sixth station. The rods, being now compared, were found to agree with the standard; and the temperature was $67^{\circ}\frac{1}{2}$.

On Tuesday the 3d of August, the rods were compared at 7 h. A.M. and found only to exceed the standard by one-sixtieth of an inch. Being arrived at the middle of the forty-first hypotenuse, a point corresponding to the forward end of the 1215th rod was transferred to the ground by the double pickets and silk-thread, as had been done at the twenty-seventh station. The measurement was then continued to the north-west extremity of the base, which was found in the whole to contain 1353 complete long rods of 243 inches each + 21 inches, where the tripod was placed, in the point which of course corresponded to the 1370th short rod of 240 inches each, equal to 328800 inches, or 27400 feet. To which distance we have yet to add 4.31 feet, being the space intercepted between the intersection on the tripod and the center of the pipe marking the north-west extremity of the base; whose total length, as given by the deal rods, without regard to expansion, or reduction of the hypotenusal line, becomes 27404.31 feet. And here it is to be observed, that the intersection on the tripod terminating the 27400 feet only over-shot the picket answering to the 274th chain by two inches and nine-tenths. But this nice agreement between the result by the deal rods, and that furnished by the rough measurement with the chain, arises from the extra-length of this last, which so nearly compensated for all the irregularities of the surface.

The measurement with the deal rods being finished, they were compared at 5 h. P.M. and found to agree with the standard, the temperature then being 75° .

Expansion of the Deal Rods.

It has been an opinion generally enough, although, as we have seen, erroneously received, that very straight-fibred deal was not at all, or but little, affected longitudinally by the humidity of the air. That we might not be led astray by trusting to fallacies of this sort, the standard rod had been provided; which being always closely shut up in its chest, except during the short interim of comparison, could feel but a small proportion of the effects which the measuring rods suffered, these being constantly exposed to the open air throughout the day, as well as to the moisture of the night, when lying under the oil-cloth canopy. The standard rod, it is true, could not be accurately compared with the brass scale: for although when constructed, brass pins, forty inches asunder, had been driven into its stem, for the purpose of such comparison, yet these had afterwards been displaced, or at least the points upon them defaced, by the planing over of the upper surface. This circumstance, which was unattended to when the operations commenced, is now of no consequence; because, from an experiment hereafter to be mentioned, the lengthening of the standard may be pretty nearly ascertained. But since there are some contradictory circumstances, soon to be mentioned, in the operation with the deal rods, which would have made a repetition of it absolutely necessary, if we had not now obtained those of a different kind, so very unexceptionable in their nature and mode of application, as, in the present case, to admit of no competition between the two results, and to render it improper on our part ever to have farther recourse to the first; so there
can

can be little doubt, that deal rods will be universally rejected by other countries, in any measurements they may have occasion to make in future.

About the 10th of July, two rods, one of New-England and the other of Riga deal, being measured by the fixed points in the great plank in Mr. RAMSDEN's shop, and having each two brass pins driven into them at the distance of twenty feet, were laid on the top of the house, where they remained until the 26th, the weather, for the greater part of the time, having been very wet. They were then taken down, and being, by means of the long beam compasses, compared with the measures on the plank, the New-England rod was found to have lengthened 0.031 inch, and the Riga rod 0.041 inch. By which experiment the fact seems to be established, that Riga red wood, notwithstanding the quantity of turpentine which it contains, is more susceptible of the effects of moisture than New-England white wood. Mr. RAMSDEN likewise finds, that the great plank so often mentioned, suffers, in ordinary summer weather, an alternate expansion and contraction, amounting at a medium to 0.0041 of an inch every day: that is to say, if the distance between the twenty-foot brass points be measured from the scale, by means of the beam compasses, in the evening, it is found to have lengthened next morning 0.0041 of an inch, by the humidity of the intervening night. In the course of the following day it contracts again to its former length, and so on. Mr. RAMSDEN has often observed this alternate change in the deal plank; but it was particularly on the 11th and 12th of August, that the quantity was actually measured. It will readily be understood, that any difference of temperature which might have happened in the brass scale, at
the

the times of comparison, was always carefully taken into the account.

Now, from this last experiment, it seems probable, that we shall not be very wide of the truth in supposing, that the standard deal rod, which lay closed up in its chest, under the canopy on Hounslow-Heath, would suffer the same sort of alternate expansion and contraction with the above-mentioned plank; that is to say, being of Riga wood, its mean expansion about the middle of the day would be $\frac{2}{10000}$ of an inch. By this quantity then we must augment the actual observed expansion of the measuring rods, in order to obtain within certain probable limits (since we cannot determine it accurately) the equation for the expansion; or that space by which the apparent measurement, given by the 1370 deal rods, should be augmented in order to obtain the true length of the base; or that which would have been given by unalterable rods, of the same original length with those of deal, as expressed in the following table.

Table of the Expansion of the Deal Rods.

Days.	N ^o of rods measf.	Hour of comparison.	Temp. of the air.	Observed expansion.	Decimal mean.	Equation for the measf. rods.	Equation for the standard.	Total expansion.		
		h.	o	In.		In.	In.	In.		
July 16	105	4	0A.M.	48	}	0.010	1.050	0.2625	1.3125	
		6	0P.M.	62						$\frac{1}{10}$ th
17	195	7	0A.M.	62	}	0.010	1.950	0.4875	2.4375	
		6	0P.M.	—						$\frac{1}{10}$ th
23	240	9	0A.M.	61	}	0.021	5.040	0.6000	5.6400	
		6	0P.M.	54						$\frac{1}{10}$ th
24	270	7	30A.M.	61	}	0.033	8.910	0.6650	9.5750	
		11	15A.M.	66						$\frac{1}{10}$ th
		5	45P.M.	64						$\frac{1}{10}$ th
Aug. 2	270	8	30A.M.	66	}	0.0125	3.375	0.6650	4.0400	
		7	0P.M.	67 $\frac{1}{2}$						$\frac{1}{10}$ th
3	290	7	0A.M.	56	}	0.017	0.493	0.7250	1.2180	
		5	0P.M.	75						$\frac{1}{10}$ th
Total	1370	-	-	-	-	-	20.818	3.405	24.223	

N. B. Although the rods were not compared with the standard on the 16th of July, yet the expansion probably was, and therefore has been estimated, at the same rate as it was found on the following day.

By examining the preceding table, it will appear, that the total expansion on the 1370 deal rods, including the small equation for the lengthening of the standard, amounts to 24.223 inches, or 2.02 feet; which being added to the apparent length of the base 27404.31 feet formerly obtained, we shall have, for the hypotenusal length, 27406.33 feet: and from this deducting 0.07 foot, the excess of the hypotenusal above the base line, or the reduction contained in the seventh column of the general table of the base, there will remain 27406.26 for the distance given, by the deal rods, between the

centers of the pipes terminating the base, reduced to the level of the lowest, or that at Hampton Poor-house, in the temperature of 63° , being that of the brass scale when the lengths of the deal rods were laid off. All this, however, supposes three things to be absolutely certain: first, that the expansion of the rods has been accurately estimated; secondly, that no error has arisen from the butting of the rods against each other, in order to bring them into contact; and, thirdly, that no mistake of any kind has been committed in the execution. When we come to give the true length of the base, as ultimately ascertained by means of the glass rods, it will appear, that one or more of these three have actually taken place; although it is most probable, that only the two first sources of error have contributed their share of the total difference between the two results. But the discussion of this point must be deferred for the present; and I shall now finish the subject of the expansion of the deal rods, by mentioning two other comparisons of them, which serve to shew still more obviously, how improper they are for very accurate measurement!

It has already been remarked, that the last week of July was so wet as to occasion a total suspension of the operations on Hounslow-Heath. On the 26th of that month, at 8 h. A M. the temperature being then 63° , the rods were compared with the standard, and found to exceed it, at a medium, one-fifteenth part of an inch. Now, if we suppose the whole base to have been measured with the rods in that state, the difference would have amounted to more than $7\frac{1}{2}$ feet, exclusive of what the standard itself might have altered from its original length.

The other comparison was made at Spring-Grove, in the beginning of September, after our operations on the heath had been finished, and the deal rods with their apparatus deposited

under the roof of Sir JOSEPH BANKS's Barn. The object here in view was the measurement of such a space as the garden would conveniently admit of, when the rods were in their dry or contracted state; and to re-measure the same space next morning, when the rods, being left out for the purpose, had imbibed all the humidity they could from the moisture of the intervening night. Accordingly, the fourth being a fine dry day, the sun shining bright, and the thermometer about 68°, seventeen stands were arranged in the long walk, with so much nicety in the same inclined plane as to appear but like one. The first or lowermost stand had a brass cock screwed to its top. The two uppermost, that is to say, the sixteenth and seventeenth, were of the fixed kind, each with a brass slide, and placed only forty-five inches asunder. The first deal rod was made to butt against the brass cock, and the rest successively against each other, until fifteen rod lengths were measured off, and a fine line drawn on the slide marking the extremity of the fifteenth. That rod being removed, forty-five inches, taken from the brass scale, were then laid off backwards from the line on the slide of the seventeenth to the slide of the sixteenth stand, where another fine line was drawn. Thus the space comprehended between this last line and the cock on the first stand, was just 300 feet, or fifteen coincident rods. During the night of the 4th, which was very fine, the rods lay on the smooth grass. About sun-rising of the 5th there came on a thick fog, which entirely dispelled about 8 o'clock. At 7 h. A.M. the rods being lifted from the grass, it was perceived, that the under sides were perfectly dry, while all the rest was quite wet with the dew that had fallen. The fourteen stands, comprehended between the first and sixteenth, having their distances gradually reduced from twenty feet three

inches to twenty feet, the operation of re-measurement was then begun, by placing the rods in coincidence with each other (which was now found to be easily and accurately effected by a few repeated strokes with a wooden wedge only) until the fifteen rod lengths were measured off, and a fine line, corresponding with the ivory on the fifteenth, was drawn on the brass slide. This line was found to be $0.1\frac{29}{32}$, or near half an inch beyond that which terminated the 300 feet the preceding evening. Hence it is evident, that the dew imbibed only in one night, or a space of time not exceeding fourteen hours, occasioned such an expansion in the deal rods, as in the whole base would have amounted to 45.484 inches.

It is sufficiently obvious, that this last mentioned experiment was more accurate, in the proportion of about fifteen to one, than any comparison we could at that time have made with the standard. But since immediately after it was finished, the sun shone out very bright, it is by no means certain, how soon the rods would again have contracted to their former length, or near it, had they been exposed to his rays. Repeated comparisons for ascertaining facts of this sort, at very short interims, are absolutely incompatible with the nature of such tedious and troublesome operations as the measurement of long bases: and here, indeed, lies the great objection to the use of deal rods, that at no time can we be certain how soon, after a comparison has been made, they may alter their length in a proportion, and sometimes too even in a sense, different from what was expected.

Description of the Glass Rods, ultimately made use of to determine the length of the Base. Tab. XIX.

It has been already mentioned, that the week of rainy weather in the end of July was employed in providing the glass tubes, and in concerting matters with Mr. RAMSDEN, relative to their construction as measuring rods. Notwithstanding their great length, they were found to be so straight that, when laid on a table, the eye, placed at one end looking through them, could see any small object in the axis of the bore at the other end.

The nature and construction of the glass rods, whereof three were finished for the operation, will be best conceived by considering, with care and attention, the plans and elevations of them, in whole or in part, to different scales in tab. XIX.; where likewise may be seen, plans and sections of the ends of the tubes, in their real dimensions, for the better understanding the several parts of the apparatus placed therein.

The case containing the tube, and which serves to keep it from bending in its original straight position, is every where of the depth of eight inches, of the same width in the middle, and tapers from thence, in a curvilinear manner, towards each end, where it is only two inches and a quarter broad. It is made of clean white deal, the two sides being half an inch, and the top and bottom three-eighths in thickness. These last are placed in grooves fitted to receive them, about half an inch from the upper and lower edges of the sides, which bending easily, and applying closely, are then firmly fastened by two rows of wood screws on each side, to the top and bottom

respectively. Thus, the depth of the sides in one sense, and the spring which they have by bending in the other, act as trusses, prevent the case from warping, and render it sufficiently strong, although at the same time, considering its great length, very light.

The plan of the middle rod represents the case with the top off, that the tube may be seen placed therein: the right and left-hand rods have the tops on, whereby may be seen the oval opening in the middle of each, shut by a mahogany lid; and also the positions of the two thermometers, with tubes bent at right-angles, so as to place the ball about two inches downwards within the case, for the better ascertaining the temperature of the glass, as will easily be conceived, by considering the representation of the tube and ball in the section across the middle of the rod.

It is to be observed, that the middle of the tube is made fast to the middle of the case in the following manner. First, around the middle of the tube, a quantity of pack-thread, immersed in liquid glue, was wound by several returns on itself, for the space of about two inches in length; and upon this mass of pack-thread, while the glue was warm, a strong mahogany collar was forced; whereby the three substances became so perfectly united to each other, that they might be considered as one only. Across the bottom of the case in the inside, three mahogany braces or girders, one in the middle, and one half-way between it and each end, are fastened, by means of screws, to the bottom and sides. These rise about $1\frac{1}{2}$ inch above the bottom, so as to place the axis of the tube, when in use, about $2\frac{1}{2}$ inches above the surface of the stands on which it rests. The end-pieces of the case are likewise of mahogany, about $1\frac{1}{4}$ inch thick. Each consists of two parts, a lower and an upper.

upper. In the lower parts, as well as in the cross braces, there are semi-circular cavities lined with broad-cloth, fitted to receive the diameter of the tube, which rests in them, and is consequently supported at five different points. The upper end-pieces, having likewise semi-circular cavities fitted to embrace the upper part of the tube, slip down upon it, when it has been, by repeated trials, brought to its true position; that is to say, the axis of the bore into the same straight line, the case being all the while supported by its extremities on two stands only, in the manner in which the rods are applied in actual measurement. The braces within the case have also their upper pieces, which, in like manner, apply closely to the tube, and are fixed to the lower ones by means of screws. The whole together serve only as stays to keep the tube in its true place from shaking; but without binding it however too closely. Lastly, the mahogany collar glued to the pack-thread on the middle of the tube, being strongly fixed by four screws to the middle brace, as may be seen in the section, is that by which the tube is kept perfectly immovable with respect to the middle of the case; while it is unconfined longitudinally in the cavities lined with broad-cloth every where else.

Both ends of the tube are ground perfectly smooth, and truly at right-angles to the axis of the bore. That end, which in measuring usually lies towards the left-hand (since most people will work the screw with the right) projects about seven-tenths of an inch without the case, and is called the fixed end, because the apparatus belonging to it is fixed. The other end towards the right-hand projects about nine-tenths of an inch, and, having a moveable apparatus, is called the moveable end.

The fixed apparatus consists of a cork about three inches in length, made of the very best material, and so nicely fitted to the bore as just to admit of being forced into without bursting it. In the middle of the cork a cylindrical brass-tube is placed, whose sides are thin, the inward end thick, and the outward end open. It receives a steel pin, whose inward end being formed into a screw, is thereby fixed into the thick metal of the tube. The steel pin carries outwardly a button and neck of bell-metal. The neck fits so very closely the open end of the brass tube as to prevent any shake there; at the same time that the inside of the button applies very justly to the ground end of the glass tube, to which the outward surface (being a true plane) is exactly parallel.

The moveable apparatus consists, like the other, of a cork and brass tube of the same length. Before the insertion of this cork, an oblong piece seven-tenths of an inch long, and two-tenths broad, was cut from it, in that part of its cylinder answering to the upper part of the outward end of the glass tube, on the inward surface of which, about half an inch from the end, a fine line had been previously cut by a diamond point. The brass tube in this cork contains within it a loose steel worm, or helical spring, something less than the interior diameter of the tube. Along the cavity formed by the spiral, there passes a steel pin, like that in the fixed end; but it is longer, and has no screw at the inward end, that being nicely ground, so as to fit a circular hole in the inward end of the brass tube, while a triangular bell-metal neck fits one of that figure in the outward end. Thus the pin moves freely backwards or forwards without any shake, and presses upon the steel spring, by means of a circular brass collar, placed for the purpose, at the inward end of the neck; while the outward
end

end is attached to a bell-metal button. The outward surface of this moveable button is spherical, described on a radius of about two inches; while the inward surface, like that at the fixed end, would apply closely to the ground end of the glass tube, but should not be pushed so far forward as to touch it. A circle and narrow slide, cut from a solid cylinder of ivory, fitted originally to enter easily the glass tube, is attached to the inside of the button by small screws, and permits the neck to pass through a hole made on purpose in the circle. The slide is about eight-tenths of an inch long, and has a fine intersection cut upon it near the inward end, made black to render it more conspicuous. Thus, two rods being brought into contact, and the fixed button of one being pressed against the moveable button of the other, the intersection is thereby pushed forwards until it coincides with the diamond line on the interior surface of the tube; whose length is so adjusted, as that, when the coincidence is perfect, the distance between the plane surface of one button, and the spherical surface of the other, is exactly twenty feet. The left-hand side of the plate represents the relative positions of the extremities of the first and second rods, when the ivory is in coincidence with the diamond line. And the right-hand side shews the relative situations of the extremities of the second and third rods, before the ivory is brought to coincidence with the diamond line, the slide being then pushed out by the action of the spiral spring within the cork.

Every rod has four wheels, two at each end. They are two inches in diameter, and connected by a common steel axis, which rises and falls in a vacuity prepared for its admission in the mahogany end-pieces, the under part of which vacuity is afterwards filled up.

A brass strap or bridle, about eight-tenths of an inch broad, passes over the top of the case, and descending down each side, bends outwards, so as to form a projection for the reception of the wheels, whose pivots turn in, but near to the lower end of the bridle, which is kept in its place by means of the two side screws working in grooves, and the milled-headed screw at top. This last serves likewise to raise or depress the wheels at pleasure.

Each rod has two cross feet, placed immediately behind their respective pair of wheels, extending outwards about $4\frac{1}{4}$ inches from the center on each side. Under their outward extremities, small pieces of hardened steel, formed into the teeth of a file, are fixed by means of screws. When the first rod has been laid in its true place, by unscrewing the milled heads, the wheels are suffered to rise; whereby the whole weight is removed from them, and thrown upon the teeth of the files, which then indent themselves into the surface of the stand, and become as it were united to it. But when the fixed button of the second rod is brought to press against the moveable button of the first, the weight being then thrown upon the wheels by screwing the milled heads at top, the rod is easily moved on by the following apparatus.

The three rods are numbered, as were those of deal, 1. 2; 3. 4; 5. 6. On the first or odd end of each rod 1. 3. and 5. there stands a brass fork, about two inches high, fixed by four screws and an oblong plate to the top of the case. On the second, or even end of each, 2. 4. and 6. there stands a brass pillar of the same height with the fork, likewise fixed to the top of the case by four screws and a circular plate. Two steel rods or hooks were indifferently used for bringing up the moveable rod (the weight then lying on the wheels) into its true place. They are

are both represented in the plate, and only differ from each other in the shape of the brass milled-headed nuts that work upon the screw, of about $2\frac{1}{4}$ inches in length, into which the right-hand end of each hook is formed. Thus, while the nut enters very freely into, and rests upon, the fork, the left-hand end of the hook has a circular hole in it, whereby it slips easily off and on of the brass pillar. By referring to the plate, it will appear sufficiently obvious, from the nature of the nut on the left-hand hook, that it could only move the rod on to coincidence, and could not bring it back again, if the business happened at any time to be overdone; in which case it was necessary to move the rod a little backwards by the hand, and then to work anew with the nut, until the coincidence was accurate: whereas the nut on the right-hand hook, having two shoulders, could either push or pull the rod forwards or backwards: and although this appeared to be an advantage, yet it was found from experience, that it rather bound the hook too much, and occasioned a kind of spring in the parts, which sometimes disturbed the coincidence on the removal of the hook; wherefore it was often applied, like the other, by placing the screw itself in the fork, and working with both shoulders of the nut behind it.

The positions of the thermometers, and mahogany oval lid on the top of the case, have already been mentioned. This last, being unlocked and removed, permits the case to be looked into, or the hand to be admitted, in order to be certain that the fastenings remain safe and entire in the inside. Brass caps, with the respective number of the rods engraved on them, are likewise screwed on the male-screws in the ends of the case, through which the extremities of the tubes project, to preserve them from accidents when not in use. And, lastly, to

VOL. LXXV. N n n strengthen

strengthen the cases, but more particularly to prevent them from being rent when long exposed to the sun's rays in the field, the sides are covered with brown linen laid on very smoothly, and carefully glued with thin glue, used as a stronger kind of paste, to which it may yet be necessary to add a coat of oil paint.

Each of the glass rods, completed in the manner above-mentioned, weighs about sixty-one pounds. Their lengths were ascertained by means of new brass points placed in the great plank, the spaces of forty inches being laid off, with the utmost care, from the brass scale, when the temperature of all had remained for the greater part of two days (August 15th and 16th) at or very near 68° . For this purpose two brass rectangular cocks, whose alternate surfaces had been previously ground together, were placed upon the plank, so as to bisect the extreme dots; in which situation they presented to each other surfaces that were truly parallel. The rods being then severally placed between the cocks * (or, as was found to be a better method,

* The first of these cocks, or that to which the fixed button was applied, had a hole in it exactly of the height of the center of the button, and large enough to permit the point of the micrometer screw to pass through it, the said screw being fixed on the farther side, or beyond the cock. Thus, while the temperature continued accurately at 68° , the fixed button, or any other plane surface, being brought up to the hole in the cock, and the micrometer point screwed so far as just to touch it, the coincidence continuing in the interim perfect, the exact distance of twenty feet was obtained between the point of the screw and the second cock; at which time the division answering to the index on the head of the micrometer was carefully noted. This being done, the cock with the hole was removed from the plank, and the rods were severally adjusted by being placed between the point of the screw and the second cock. This substitution of the micrometer point, instead of the first cock, was found necessary; because, during the operation of adjustment, the temperature would sometimes change a degree, generally

method, between the point of a micrometer screw, supplying the place of the first cock, and the second) the ivory intersection was at first necessarily carried beyond the diamond line, so as to make the intermediate space less than it should be, until by the gradual grinding down of the moveable bell-metal button, it was enlarged to twenty feet, as then shewn by the accurate coincidence of the intersection with the diamond line.

It was by these distances in the great plank, prolonged to twenty-five feet, that the new length of the steel chain was now settled, so as to obtain the full one hundred feet at four measurements. At this time too, brass points were introduced into the chain at every twenty-five feet, whereby its extent may be compared on any future occasion; but the temperature had now fallen to $66^{\circ}\frac{1}{2}$.

Disposition of the Stands for the double measurement with the Chain and Glass Rods; description of the apparatus then applied to the ends of the Chain; and ultimate continuation of the measurement with the Glass Rods alone. Tab. XVII. and XIX.

From the various circumstances already mentioned, in the course of this tedious, yet necessary recital, it had been for a considerable space of time foreseen, that the result given by the measurement with the deal rods must be entirely rejected,

generally in excess, from handling the instruments. One degree of alteration, producing a difference of about $\frac{1}{10000}$ th part of an inch in the twenty feet, was very easily and accurately allowed for by such a micrometer as this, which shewed the coincidence of the ivory intersection with the diamond line to be more or less perfect, when the head of the screw was moved two divisions, that is to say, $\frac{2}{10000}$ ths or $\frac{1}{5000}$ th part of an inch.

and that by the glass rods adhered to, as every way deserving of the preference; because of the obvious impropriety there would be, in taking a mean between one indisputably good and another less perfect; however small or trifling in reality the difference of the two might ultimately be found, on a minute and scrupulous comparison.

In order, therefore, to avoid any repetition of the operation with the glass rods, and at the same time to give something like a fair trial to the chain, it was proposed, that a double measurement should be carried on with both at once; that is to say, that the number of stands, and several other parts of the apparatus, should be so far augmented, as to admit the chain to be placed twice in advance, and then the rods to follow in succession on the same stands. Accordingly, the various articles having been sent to the north-west end of the base on the evening of the 17th of August, the operation of the double measurement commenced next morning the 18th.

By referring to tab. XVII. it will be seen, that seventeen stands were necessary for supporting the chain, the apparatus attached to each end of it, and ten coffers, whereof every five made about ninety-eight feet, in order that one length of the chain being measured off in the first five, it might be drawn forward into the last five, and so on. These seventeen stands were disposed of in three groups of three each, and four intermediate, between the central and extreme groups. The middle or slide stand of each group (so distinguished because some of them had brass slides on their tops) supported the handle of the chain, and of course received the traces made at the feather-edged pieces of brass, terminating the beginning and ending of the hundred feet. Thus, there were in all six stands, intermediate to those in the center of each group that supported

the ninety-eight feet of coffering, which was kept so much short of the hundred feet, that its extreme parts might not rest upon, or even touch, the central stands. To that on the left of the center was attached the apparatus for the first or zero end of the chain; and to that on the right of the center was attached the apparatus for the last end of the chain. When the second chain length had been measured off, the first and sixth of the coffer stands of the first chain were moved forward to prepare for the third chain; and the four remaining coffer stands were raised, until their surfaces came into the same plane with the slide stands, for the reception of the glass rods. The space by which these stands were raised was about three inches; for so much higher was the surface of the intersole or flooring of the coffers than the stands which supported them.

The apparatus attached to the first end of the chain, or that which served to pull it back to the point of commencement, while a weight continued suspended at the farther end, consists of two parts, as may be seen by referring to the left-hand side of tab. XVII. First, a small wooden frame, fitted to slip on to the top of any one of the ordinary stands, placed immediately to the left of that which supports the handle. Secondly, a flat steel rod, about two feet in length, wherein a number of holes are pierced, about an inch asunder, for the reception of a steel pin placed in one of the holes, as best suits the distance of the stand from the handle. That end of the steel rod nearest to the end of the chain is formed into a screw about four inches in length, and it receives upon it a forked hook fitted to lay hold of the straight part of the handle of the chain. Within the forked hook there works a strong milled-headed brass nut, which acting upon the bottom of the fork, the chain is thereby pulled back, until the wire suspending the plummet

from

from the dart on the feather-edge coincides with the point of commencement on the ground underneath ; for which purpose there is a hole in the top of the stand through which the wire passes. The apparatus stand, thus serving to pull back the chain, was commonly loaded with double weights, placed on the two hindermost legs.

The apparatus for the last end of the chain consists, like the former, of a small wooden frame that can be readily slipped upon any of the common stands, as may be seen by referring to the right-hand side of tab. XVII. This frame carries a pulley, over which a rope passes having fourteen pounds weight suspended at one end of it, while a forked iron hook at the other end lays hold of the straight part of the brass handle. By means of these two apparatuses the chain is always kept to the same degree of tension in its coffers, in each of which a thermometer was placed to indicate the temperature ; the whole being covered up from the direct rays of the sun by a narrow piece of linnen cloth, stretched along it from one end to the other.

Each coffer consisted of three boards about half an inch thick. The sides were about five inches deep, nailed at the middle to an intersole bottom of four inches, in such manner as to be represented in section by the letter H. They were ill made, being by their parallelogram shape apt to warp, which might have been prevented by giving them the figure of the cases of the glass rods, that is to say, making them wide in the middle and narrow at each end.

We are now to proceed to give some account of the double measurement with the chain and glass rods ; wherein it must be remembered, as also in continuing the operation with the glass rods alone, that in referring to the map for the daily progress in the work, we are going from the forty-sixth towards the first station ;

station; and in having recourse to the general table of the base, for altitude, temperature, or correction for expansion, we are ascending from the bottom towards the top, contrarily to the order in which the operation with the deal rods was conducted.

On the morning of the 18th of August, the stands with the various parts of the apparatus being placed in the manner just now described, the operation was begun by bringing the first end of the chain to coincide with the intersection on the tripod, answering to the end of the 1370th deal rod, and 4.31 feet distant from the center of the pipe terminating the north-west extremity of the base. The chain being stretched along its five coffers by the fourteen pounds weight suspended over the pulley at the farther end, and the temperatures of the five thermometers being registered in a book kept for that purpose, a fine trace was made on a piece of card fastened under the feather-edge at the farther handle, denoting the end of the first hundred feet. The chain being then moved on into the next five coffers, those that had been thus vacated were carried forward to prepare for the third chain length, and thereby permit the first set of stands to be elevated for the reception of the glass rods; and so in succession with the others.

In this manner we proceeded, and in the course of the day were only able to measure the length of ten chains, or 1000 feet, being the forty-sixth and forty-fifth hypotenuses of the base, the first of 400 and the last of 600 feet. Being arrived at this point it was found, that the fine line on the brass slide, marking the extremity of the tenth chain, fell short of another fine line on the same slide, denoting the end of the fiftieth glass rod, just two-tenths of an inch. Now it will appear hereafter, when we come to shew, by the experiments with the pyrometer, what the real contractions of the chain and
glass

glass rods were, for the degrees of difference of temperature * below that in which their respective lengths were laid off, that this small apparent difference of two-tenths of an inch, between the two modes of measuring the thousand feet, should have been 0.17938 in. to have made the two results exactly agree, which is a real difference of only 0.02062 of an inch. Supposing then every thousand feet of the base to have been measured by the chain with the same attention, and consequently with the same, or nearly the same success (and therefore cannot be any reason to doubt of the practicability) we shall have 27.404×0.02062 in. = 0.565 in. or a defect of something more than half an inch on the whole length of the base.

* When the length of the chain was laid off, the heat was $66^{\circ}\frac{1}{2}$, and that of the glass rods 68° . They will, therefore, only agree with each other accurately in these respective temperatures. The mean of twenty thermometers for the four chain lengths of the forty-sixth hypotenuse gave a heat of $61^{\circ}.6$; and for the six chain lengths of the forty-fifth, the mean of thirty thermometers gave $59^{\circ}.75$. The temperature of the 400 feet of glass by the mean of forty thermometers was $65^{\circ}.3$; and of the 600 feet, by the mean of sixty thermometers, it was $60^{\circ}.8$. Now, from these data, and the expansions of steel and glass, as determined by the pyrometer, the computation will stand as follows:

	o	o	o	In.	In.	In.	
Steel	{	400	66.5 - 61.6 = 4.9	× 0.03052 = 0.14955	}	= 0.45856	{ contract. of 1000 feet.
		600	66.5 - 59.75 = 6.75	× 0.04578 = 0.30901			
Glass	{	400	68.0 - 65.3 = 2.7	× 0.02068 = 0.05584	}	= 0.27918	{ contract. of 1000 feet.
		600	68.0 - 60.8 = 7.2	× 0.03102 = 0.22334			

The 1000 feet of steel should have contracted more than		} = 0.17938
the 1000 feet of glass,	-	
But the difference was found to be	-	= 0.20000

Therefore the error of the chain in defect was $0.02062 \times 27.404 = 0.565$ in. or little more than half an inch on the whole base.

So nice an agreement between two results, with instruments so very different, could not fail to be considered as astonishing; and as it rarely happens, that the graduation of thermometers will so nearly correspond with each other, as not to occasion a much greater error, all were very desirous that it could have been farther confirmed by continuing the operation in the same way through a more considerable proportion of the whole length. But besides the tedious nature of the double measurement, owing to the multiplicity of stands, platforms, coffers, and other articles, that were now successively to be moved forward, and for which purpose it had been found necessary to re-inforce the party of soldiers with six additional men; the operation had already trained out to a much more considerable length than had been expected; the summer was now far advanced, and the continuance of good weather uncertain; the coffers likewise for the chain, having been constructed in a hurry, were found to be defective: in short, all these reasons contributed to induce us to give up, for the present, any farther experiment with the chain, and to proceed with the glass rods alone in the completion of the measurement.

Accordingly, on Thursday the 19th of August, the operation with the glass rods was continued for the five hypotenuses, from the forty-fourth to the fortieth inclusive. It will be remembered, that in proceeding with the deal rods, double pickets had been placed in the ground, at the middle of the forty-first hypotenuse, or that point which terminated the 1215th rod, reckoning from the south-east, or the 155th from the north-west end of the base. Now, in returning to this point with the glass rods, the extremity of the 155th fell short of the silk thread stretched from picket to picket, just one-tenth of an inch. The expansion of the brass standard scale, and

that of glass being taken into the account, it appears, that the small expansion * of the deal rods from the humidity of the air, must, at this point, have exceeded what it was estimated at in the general table by 0.931 of an inch, supposing no error of any kind whatever to have arisen in the execution, from bringing the rods into contact, or otherwise.

On Saturday the 21st of August, the measurement was resumed at the thirty-ninth station, and continued for five hypotenuses to the thirty-fifth inclusive.

This day, about noon, HIS MAJESTY deigned to honour the operation by HIS presence, for the space of two hours, entering very minutely into the mode of conducting it, which met with HIS gracious approbation.

On Monday the 23d, the mensuration was farther continued for five hypotenuses, that is, to the thirtieth inclusive.

On Tuesday the 24th, we proceeded with the measurement for the space of seven hypotenuses, finishing the business of the day at the twenty-second station.

	In.	
* 155 deal rods = 3100 feet	{	+0.383 for 1° excess of temperature of the brass scale from 62° to 63°. +0.651 proportionable part of the estimated expansion from humidity.
	—	
		+ 1.034 equation of the deal rods on 3100 feet.
	—	
155 glass rods = 3100 feet	{	+2.301 for 6° excess of the heat of the brass scale from 62° to 68°. -0.436 observed contraction of the glass from the 11th and 12th columns of the table. +0.100 by which the 155th rod fell short of the thread.
	—	
		+ 1.065 equation of the glass rods on 3100 feet.
	—	
	0.931 {	Difference of the two equations, under-rated in the expansion of the deal rods.

It will be remembered, that in carrying on the operation with the deal rods, double pickets were left in the ground at the twenty-seventh station, answering to the extremity of the 810th rod from the first, or the 560th from the last end of the base. Now, on arrival at this point, the 560th glass rod overshoot the silk thread, stretched from one picket to the other, 2.525 inches. Here again we find, that the lengthening * of the deal rods from the moisture of the atmosphere differs but little from what it has been estimated at by comparison with the standard, being over-rated only two-tenths of an inch on the 560 rods. In this day's operation, in passing the bridge laid over the old river, the measurement, instead of being made in the hypotenusal, was carried on in the level line, for the space of twenty rods, namely, fifteen rods of the twenty-seventh, and five of the twenty-sixth hypotenuse; which occasions the alteration in the reduction of these two spaces, marked with asterisks in the general table.

As some trouble had been found to attend the crossing of the great road, in the first measurement, owing to the number of carriages that were continually passing, the depth of

*	560 deal rods =	11200 ft.	{	In.	+ 1.390	for 1° excess of heat of the brass scale from 62° to 63°.	+ 5.258	estimated expansion from moisture,
			+ 6.648 equation of the 560 deal rods.					
			560 glass rods =					
			11200 ft.					
			{					
			+ 8.343 for 6° excess of heat of the brass scale from 62° to 68°.					
			+ 1.821 observed expansion of glass } from columns 11th and 12th.					
			- 1.191 observed contraction of ditto }					
			- 2.525 over-shot the silk-thread.					
			+ 6.448 equation of the 560 glass rods.					
			0.200 { Difference over-rated in the expansion of the 560 deal rods.					

the ditches, and height of the banks of the old Roman way; therefore treffels, suited for the purpose, had been now prepared: and lest any accident might have happened in conducting this part of the operation, so as to oblige us to a repetition, double pickets were placed in the usual manner in the ground two rod lengths from the twenty-sixth station, to which we could have referred, without going back as far as the tripod left at the twenty-ninth station, the point from which we had departed in the morning.

Bad weather prevented any progress being made on the 25th; and, on the 26th, all that could be done was to measure the twenty-second and twenty-first hypotenuses.

On Friday the 27th, the work went on more expeditiously, having in the course of that day measured six hypotenuses, and placed the tripod at the fourteenth station.

On Saturday the 28th, eight hypotenuses were measured, and the tripod was placed at the sixth station. In this day's operation, being arrived near the bridge laid over Wolfey River, double pickets were placed in the ground in the point answering to the extremity of the 1172d rod, reckoning from the north-west, or the 198th rod from the south-east end of the base, that we might recur to them in case of accident; and the eighteen rod lengths, between this point and the sixth station, were measured on the level, instead of the hypotenusal line, which required the alteration of the reduction as distinguished by the asterisk in the general table.

On Monday the 30th of August, the measurement with the glass rods was completed*; when the extremity of the 1370th rod

* The gentlemen who were present at, and assisting in, the last day's operation were Captain BISSET, Mr. GREVILLE, Sir WILLIAM HAMILTON, Mr. LLOYD, and

rod over-shot the center of the pipe terminating the base towards the south-east by 17.875 inches, or 1.49 foot. Hence, when the several equations for expansions are respectively taken into the account, we find, that the alteration of the deal rods from the humidity of the air, which, by comparison with the standard, was apparently most considerable in the first and second sections of the base, has now wholly vanished; that is to say, the total amount of it has been over-rated by 20.964 inches*; and this is the contradictory circumstance that has been formerly alluded to.

I have already suggested what appear to me to have been the only three possible causes of this difference, found between the estimated and real expansion of the deal rods; and as we are to abandon that measurement entirely, it is of little or no importance now to endeavour to discover, were it possible, whence it may have arisen. If any error was actually com-

and Dr. USHER, Professor of Astronomy in the College of Dublin. This last gentleman was so obliging as to observe, with the most scrupulous attention, throughout the whole operation with the glass rods, that the coincidence of the second with the first remained undisturbed, while that of the third with the second was completing.

In.

* 1370 deal rods = 27400 ft.	}	+ 3.389 for 1° of the brass scale from 62° to 63°. + 24.223 estimated expansion from humidity.
<hr style="width: 20%; margin: 0 auto;"/>		
+ 27.612 equation of the 1370 deal rods.		
<hr style="width: 20%; margin: 0 auto;"/>		
1370 glass rods = 27400 ft.	}	+ 20.336 for 6° of the brass scale from 62° to 68°. + 5.989 observed expansion of glass } from columns 11th - 1.802 observed contraction of ditto } and 12th. - 17.875 space by which the 1370th rod over-shot the pipe.
<hr style="width: 20%; margin: 0 auto;"/>		
+ 6.648 equation of the 1370 glass rods.		
<hr style="width: 20%; margin: 0 auto;"/>		
20.964 over-rated in the total expansion of the deal rods.		

mitted, which is the least of all probable, it could only have happened at the place of the tripod, by bringing a wrong point of the stem over it when the operation was resumed. But it is well known, how much care and pains were taken to prevent any thing of that sort. Indeed the hypothenuſal diſtances, as given by the chain, agreed ſo nearly among themſelves, that even a foot or ten inches would have made ſo remarkable a difference in the ſituation of the next picket as could not have paſſed unobſerved. Beſides, in returning with the glaſs rods, after paſſing the Staines Road, the meaſurement was gradually found (without any leap whatever) to over-ſhoot the pickets, and at laſt over-reached the fourth-eaſt pipe by 17.875 inches. I am therefore inclined to believe, that the difference ariſes partly from what may have been loſt by conſtantly butting one rod againſt the other, whereby the end of the 1370th did not reach ſo near to the north-weſt pipe as it ought to, and would have done, if the rods had been applied to each other by coincident lines. It muſt, however, be confeſſed, that the near agreement between the glaſs and deal rods in the upper part of the heath ſeems not perfectly reconcilable to this ſuppoſition. Nevertheleſs, the deſcent being quickeſt, and the irregularities of the ſurface much more conſiderable in the lower than the upper part, might produce ſome effect in one which did not take place in the other. But the chief part of the difference I take to have proceeded from over-rated expansion; that is to ſay, the rods, when brought into uſe, contracted ſooner than we imagined, and thereby gave a ſhorter meaſure than what was aſſignable to them from the mean of any two or more comparisons.

The last day of August was employed in discharging the party, and removing the various parts of the apparatus to Spring-Grove House.

Description of the Microscopic Pyrometer, made use of for determining by experiment the expansion of the metals concerned in the measurement of the Base. Tab. XX.

Having, in the preceding part of this Paper, given a very minute account of the actual operations in the field, that the Public, being thus informed of every circumstance, might be the better enabled to judge of the accuracy of the result, it remains yet to point out, in what manner the equations for the expansions of the standard scale, steel chain, and glass rods, applied to the apparent measurement of the base, in several of the preceding notes, have been obtained by means of experiments with the pyrometer.

It is sufficiently well known, that many years ago, a very ingenious and valuable Member of this Society did publish in the Philosophical Transactions (vol. XLVIII. 1754, N^o 79.) an account of experiments made with a pyrometer of his invention. No doubt was entertained of the accuracy of the experiments here alluded to; on the contrary, they will be confirmed by the account now to be given of these recently made, with which they very nearly agree. But as different pieces of metal of the same kind are certainly susceptible of different degrees of expansion, it was judged best, on the present occasion, to put rods to the test of those very metals that had been made use of in the actual measurement of the base.

For, supposing both sets of experiments to have been made with instruments equally perfect, and to have been in other respects equally well conducted, this must always be considered as the most unexceptionable method. Besides, the expansion of rods of the length of five feet being ascertained, the unavoidable error of observations of this delicate nature, becomes lessened in proportion to the excess of their length above shorter rods. In these new experiments too, another sort of pyrometer, invented by Mr. RAMSDEN, has been applied, of such accurate construction that it seems not easy to improve it.

The microscopic pyrometer, so named because, by means of two microscopes attached to it, the expansion is measured, consists of a strong deal frame five feet in length, nearly twenty-eight inches broad, and about forty-two inches in height. The elevation of the eye-piece side, or that which presents itself to the observer, and also of the micrometer end, or that which is towards his right-hand, as well as the general plan of the top, are represented by a scale of one inch to a foot, or one-twelfth part of the real dimensions, in tab. XX. where likewise may be seen the angular view of the fixed end, together with plans, sections, and elevations, of several of the principal parts, done to larger scales. From these, it is hoped, the construction of the machine will be easily understood, without entering into a minute description of the almost numberless smaller parts whereof it is composed.

On the top of the frame, two deal troughs, upwards of five feet in length, are firmly screwed. That towards the observer overhangs the frame something more than an inch: that on the farther side is even with the back part. Each of these troughs, which are about three inches square in the inside, contains a cast-iron standard prism, whose sides are $1\frac{1}{4}$ inch.

The

The manner in which the prisms are fastened to the bottoms of their respective troughs, and the nature of the apparatuses they carry on their extremities, will be readily conceived, by referring to the particular plans and elevations of them, comprehended in the group of eight small figures towards the right-hand of the general plan. Four of these appertain to the left-hand or fixed microscope; and the other four to the right-hand or micrometer microscope, so distinguished because it has a micrometer attached to it. By means of the brass collars which embrace the prisms, their left-hand or fixed ends are screwed down extremely fast to the brass pieces whereon they rest, so as to be perfectly immoveable there with regard to their troughs; whereas their right-hand ends are kept easy, yet without shake, in their collars, that they may contract or lengthen freely as the temperature may require, without occasioning any strain upon the parts. The prism in the nearest trough may be called the eye-piece prism, because it carries the eye-pieces of the microscopes; and that in the farther trough, the mark prism, because it carries the marks or cross wires at which the microscopes respectively point. The troughs are covered with pitch in the inside, to make them hold water; and each has a cock in the left-hand end for discharging it.

Between the two deal troughs, one of copper, as a boiler, is placed, somewhat shorter than the former, but still upwards of five feet in length. It is about $2\frac{3}{4}$ inches broad, and $3\frac{1}{2}$ in depth. The center of the boiler, or rather the center of the object lens which stands in it, as we shall have occasion soon to point out, is distant from the cross wires of the mark 5.81 inches; and from the wires of the micrometer attached to the corresponding eye-piece 20.33 inches. The boiler rests on five small rollers, one being fixed to each end of the frame, and

the other three to the braces which run across it. This copper trough has likewise a cock in the left-hand end; and in the general plan a cast iron prism is represented in it; but this last carries no apparatus, as those in the wooden troughs do, being exactly of the length of five feet, and only placed there as one of the rods whose expansion was tried, and to shew that the machine was capable of receiving a rod of that weight and magnitude.

By referring to the general plan it will be seen, that twelve lamps are made use of to bring the water in the copper to boil. They stand on four shelves, three in each compartment formed by the cross-braces of the frame. They can readily be pushed forwards or drawn backwards, and when actually in use, their handles are only seen, projecting from under the copper. It was found, by burning oil in the lamps, the heat of the water could not be raised above 209° or 210° ; but with spirits of wine it was brought into violent ebullition. The plan of the frame likewise shews, that the tubes of the microscopes are sub-divided into several distinct parts; and that one of these parts is attached by a collar to a mahogany prism, which reaches from one end to the other. But the use of these contrivances it will be best to defer speaking of, till after having described the apparatuses that are placed within the copper boiler.

At the bottom of the plate the boiler is represented, both in plan and longitudinal section, to a scale of one-fourth part of its real dimensions. It contains within it two brass slides, the one long and the other short; which, from the braces that bind the cheeks together, very much resemble the form of a ladder. The long slide, whose cheeks are $1\frac{3}{4}$ inch deep, reaches almost the whole length of the copper, although every where unconnected with it except at the points A and B. At

the first of these, two strong pieces of brass, fixed to the cheeks, and notched underneath, embrace the ends of a brass cylindrical bar fastened to the bottom. At the last, the cheeks of the slide rest on a roller. Whence it follows, that the copper and slide remain immoveable with regard to each other at A; but from thence, towards either end, they have full liberty to change place; that is to say, to expand by heat, or contract by cold, in any proportion their different natures may require. The left-hand end of the slide is shut up by a strong perpendicular piece of brass, connected with the two side rings which support the object lens of the fixed microscope, whose center corresponds accurately with its inward face. This piece being firmly screwed to the cheeks of the slide, and counter-arched outwardly, forms a strong butt for the fixed end of the expanding rod (supposed here to be the steel bar) to act against. Within the right-hand end of the long slide, rests a short one of about $14\frac{1}{2}$ inches in length, whose cheeks are $1\frac{1}{4}$ inch deep. Its outward end, at C, rests on the cylindrical surface of the last brace of the long slide, fitted purposely to receive it; while a narrow longitudinal bar fixed in its inward end, at DE in the section, moves freely in the notch of a bridge F, framed for it in the long slide. The outward end of this short slide is shut up in a similar manner with the opposite end of the long one.

This end-piece is also connected with the two side rings which support the tube containing the object lens of the micrometer microscope, whose center is perpendicularly over its inward face, and being fortified outwardly by an edge bar, it forms a butt for the expanding end of the rod that is in experiment to push against. By attending to the plate it will be perceived, that to this end of the boiler a brass tube (R) is fixed, which contains within it a brass rod, surrounded by a

helical steel spring; which acting upon a broad shoulder of the rod prepared for the purpose, thereby presses its inward end, which enters the boiler, against the perpendicular surface of the end-piece of the short slide. Thus, the farther end of the rod in experiment, supposed now to be in its contracted state, is constantly made to bear against the surface that is under the fixed microscope. But on the application of heat, the irresistible force of expansion in the rod obliges the spring to give way; the short slide changes its place, and with it the object lens of the micrometer microscope moves on a space proportionable to the degree of heat that is applied; and it is this distance, measured by means of the micrometer, as hereafter will be shewn, that determines the quantity of expansion, or the space by which the rod has lengthened. From the plate it will be further observed, that the rod in experiment rests on the surfaces of three rollers, about an inch in diameter; and by means of three pair of milled-headed nuts $1\frac{1}{2}$ inch in diameter, which move on axes that are formed into screws, until they almost touch the sides of the rod, this is kept in its true central position, whatever may be its form or lateral dimensions.

The microscope towards the left-hand has been denominated fixed, because it corresponds with the first or fixed end of the rod in experiment, and never changes its place while these are of the length of five feet. But it appearing to be of consequence, that the expansion of the standard brass scale, which is not quite forty-three inches long, should be determined, the pyrometer has therefore been adapted for the reception of any rods less than five feet, whereby it is made more universally useful. For this purpose it becomes necessary to move the marks and eye-pieces of the fixed microscope, along their respective prisms,

to

to the proper position for the rod that is to be tried. Nevertheless the object lens remains in its original place; and in its stead another lens, of the same focal distance, is fixed on a similar end-piece, that can be firmly clamped to any corresponding place whatever of the cheeks of the long slide. Hence will appear the reason for breaking the screening tubes of the microscopes into several parts, and the use of the mahogany prism, along which the thick part of the tube moves from one end to the other.

The pyrometer, since it was first made and tried, has undergone several small alterations, by way of improvements, which it is now unnecessary to describe particularly. One of these was the application of cross levels to the parts of the tube (SS in the general plan) connected with the object glasses. The manner in which they are fixed on will appear from the representations of them in the lowermost left-hand angle of the plate. And the section at the right-hand angle shews the appearance of the double brass hook, universal joint, and milled-headed nut, applied across the middle of the boiler (at TU) whereby the levels are brought to be consistent, when the water is boiling, with the position they had been adjusted to when the temperature was at freezing; that is to say, they are kept parallel to themselves in both states. This was thought necessary, because the application of the boiling water sunk the middle of the slide a small matter, and thereby made the levels run outwards.

The micrometer so often mentioned, being a very essential part of the machine, is represented both in elevation and horizontal section to the full size. Its chief parts consist of a micrometer steel screw, which works in the square nut of a brass slide, while the plane part of it enters into a long brass socket,
nicely

nicely ground to receive it, and thereby preventing all shake. To the square nut, one end of a watch chain is attached; the other end having passed around is fixed to a barrel, which contains a watch spring coiled up in the usual manner. By this contrivance, any loss of time in the motion of the moveable wire, fixed to the square slide, is effectually prevented, whether the screw be turned backwards or forwards. The fixed wire, so called because it is only made use of occasionally, appears in the elevation to the left-hand of the former, and is farther removed from the observer, being attached to the oval slide which bounds the field of the micrometer. This wire is moved by the insertion of a milled-headed key (although not represented in the plate) fitted to slip upon the square end of its proper screw, which may be seen, in the elevation, projecting above the micrometer head. It has but little motion, being only intended for the measurement of small differences of expansion, or any small space, by leaving it there, while the other wire is repeatedly brought to coincide with, and again depart from it. For particular purposes this wire may be useful; nevertheless, the instrument would have performed very well without it.

The construction of the microscopes will be readily understood, by referring to the figures under that head on the right-hand side of the plate; where the relative situations of the different eye-glasses, with regard to the wires or place of the magnified image, as well as to the eye, are truly represented in their real dimensions; but the distances from these to the object lenses and marks respectively, are contracted or broken off, from want of sufficient room to delineate them otherwise. To increase the angle of vision in microscopes, it is always necessary that they should have at least two eye-glasses, and the fixed microscope in the plate shews them in their

their usual position, the image from the object lens there being formed between the two, that the dispersion of rays in the first may be corrected by that of the second. But although this construction serves perfectly well every purpose of the fixed microscope, yet it could not answer in the moveable one, to which the micrometer is attached, where equal parts of an image, or their motion, are to be measured by the equable motion of the object lens, as shewn by the micrometer: for in that case, the interposition of an eye-glass before the image was formed, would not only have diminished its size, and thereby rendered the measure less accurate; but likewise, by refracting the oblique pencils more than those nearer the center, it would have destroyed the equality of the scale, and made equal parts of the object itself to have been represented unequally in the magnified image, and consequently erroneously measured by unequal parts of the micrometer. It was to remedy a defect of this sort that Mr. RAMSDEN proposed his new system of eye-glasses, described in the Philosophical Transactions, vol. LXXIII. 1783, N^o 5. And he has here applied that system in the construction of the micrometer microscope; where it will be perceived, that both glasses stand between the eye and the image, whereby the greater magnitude of this last is obviously preserved, as well as the just similarity of all its parts to those of the object itself.

With regard to the scale of the pyrometer, it is, in the first place, to be observed, that the head of the micrometer screw, which is nine-tenths of an inch in diameter, is divided into fifty equal parts, each of which being reckoned two, it is therefore numbered to 100. Fifty-five revolutions of the head, being equal to 0.77175 of an inch, as measured with great accuracy by Mr. RAMSDEN's straight-line engine, it follows,

follows, that there are 71.27 threads of the screw in an inch; that seven revolutions and nearly $\frac{1}{1000}$ th parts move the wire of the micrometer one-tenth of an inch; and that $\frac{1}{1000}$ th part of a revolution, or half a division, answers to a motion of something more than 0.00014 of an inch.

Having thus obtained the number of revolutions and parts of the micrometer (7.13) corresponding to one-tenth of an inch at the wires, it is sufficiently obvious, that the number answering to one-tenth LM at the mark being likewise obtained, and added to the former, their sum will give the measure of one-tenth at the object lens, or the space by which the expanding rod has lengthened, as shewn by the motion of the lens from *o* to *p*. This measure of one-tenth of an inch at the mark was ascertained in two different ways, and the results exactly agreed with each other. In the first place, a very thin ivory slide, whereon several twentieths of an inch were nicely divided by exceeding fine lines, was prepared, and made to move in the mark where the brass slide now exists. A candle being then placed behind it at night, while the pyrometer stood within doors, and the micrometer wire being repeatedly moved by the screw, its coincidence with the lines was distinctly seen through the ivory; whereby two of the spaces were found to be measured by 24.93 revolutions of the head. The second method was, by means of two exceeding fine wires placed parallel to each other on the brass slide, where they now remain, at the distance of one-twentieth of an inch on each side of the intersection wires, as may be seen by observing the real mark, or rather its magnified image, as shewn in the oval field of the micrometer, in the central figure of construction. The revolutions of the micrometer answering to the distance between these parallel wires was, as before, found to be 24.93; which being

being added to 7.13, we have 32.06 for the number of revolutions measuring a motion of one-tenth at the object lens, or the expansion of one-tenth. In this manner Mr. RAMSDEN obtains the scale of his pyrometer in the easiest and most simple way imaginable, without any necessity for knowing the absolute distances of the object lens from the wires of the mark on one hand, and those of the micrometer on the other; distances not easily ascertained by actual measurement, on account of the position of that glass in its cell, which cannot conveniently be come at. Thus, in tab. XX. as well as in the annexed figure, LM being the object at the distance of the mark, equal to one-tenth of an inch; then ml will be its magnified image, in proportion to the former as mo is to oM . And, if through the point p , the place to which the object lens o has been carried by the motion of the expanding rod, a line Mq be drawn parallel to Ll , we shall have $ml = 24.93 + lq = 7.13 = mq = 32.06$, the number of revolutions of the micrometer measuring op the expansion. Having thus obtained the total number of revolutions corresponding to mq ; and having likewise measured the total distance $mM = 26.144$ inches, a space easily ascertained between the wires of the micrometer and those of the mark, the partial distances mo and oM may then be readily found by computation: for $mq : ml :: mM : mo = 20.33$ inches; and $mq : mM :: op : oM = 5.814$ inches.

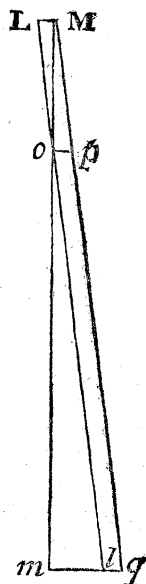

In order to finish the description of the pyrometer, it is only necessary to observe farther, that the circular scale, seen in the elevation of the micrometer, whose zero appears

VOL. LXXV. Q q q

pears to coincide with the dart on the plane part of the brass, is that which serves by its motion to register the turns of the head. A forked key, fitted to enter the holes near the circumference of the circle, is made use of for the adjustment of this zero. The circle should never be turned backwards or towards the left, lest the watch chain should thereby be thrown off the barrel, but always forwards or towards the right, even if it should be necessary to move it almost an entire revolution. The zero of the head is that which should be first brought to correspond with its proper dart. They may be seen to coincide in the horizontal section of the micrometer; and the departure of zero from this dart, indicates, by the number of divisions that are intercepted, the value of any fractional part of a revolution.

Account of the experiments with the Pyrometer.

Although the instrument which I have here endeavoured to describe was begun early in the winter of 1784, yet it was not finished till the beginning of last April; at which time it was brought to Argyll-Street, and being placed truly level on the stone pavement of the yard, was covered with an oil-cloth canopy, that the experiments might not be interrupted by rainy weather.

To fill the three troughs completely it required from twenty-five to thirty pounds of pounded ice, which was always put in with great care, so as to apply as compactly as possible to the standard prisms and rod respectively, with but little common water*

* When common water was used, although not in any very considerable proportion, the thermometer kept always half, and sometimes three quarters of a degree above 32°.

at first added ; it having been found in these experiments, that ice water only, such as drains from the ice itself, is that which should properly be made use of to mix with the pounded ice, in order to bring the whole mass to the true freezing temperature. Being at the commencement uncertain what time might be necessary for the rods, especially when of so large a size as the standard prisms, to acquire the just temperature of freezing, at first the ice was put into the troughs over night, to prepare for the continuation of the experiment next morning. But after many repeated trials, this precaution was found to be needless ; a quarter of an hour being more than sufficient to give to all the freezing temperature, as well as to render the lens on the expanding rod stationary, after the water supplying the place of the ice had been brought fairly to boil.

The instrument, in its first state, having in some cases made the expansion appear to be progressive, and not equable ; therefore its rate was attempted to be ascertained by noting the progression answering to 60° , 120° , and 180° above freezing. But when the instrument was rendered perfect, and that no sensible difference was found between the expansion at the lower and that at the upper part of the scale, a fair mean being taken between its ascending and descending rates, and allowing for the difficulty of keeping the water, for any length of time, precisely to the same intermediate heat ; then this tedious mode of conducting the experiments was given up, and the expansion for 180° was at once determined by bringing the water to boil around that rod, which but a little before had been lying in melting ice, and which the standard prisms still continued to do throughout each experiment, care being taken to have a supply of pounded ice always ready to keep these two troughs quite full.

Two observers are necessary for the effectual application of the pyrometer. He who observes with the fixed microscope, takes care that its object lens is kept in its true place, that is to say, that the wire in the eye-piece accurately bisects the intersection wires of the mark. This he is enabled to do by means of the apparatus attached to the fixed end of the boiler, as will be best conceived by observing the plan (at WX) along with the elevation of that end placed near it. The apparatus consists of two milled-headed screws, working in brass plates fastened to the end of the frame, and acting against a small cock which projects from the lower part of the boiler, whereby this last receives such longitudinal motion to and fro on its rollers, as is sufficient for the adjustment of the lens. He who observes with the micrometer microscope, having brought the zero of the micrometer head to its dart, as shewn in the horizontal section, and also the revolution zero to its dart, as represented in the elevation, takes care, when the rod has acquired the freezing temperature, that the micrometer wire bisects the intersection wires of its proper mark. This he effects by working with the milled-headed screw, represented in the plan and elevation of that mark, whereby the mark itself is moved until the bisection is accurate; and during the whole of this time, the first observer must be extremely attentive to keep his lens adjusted.

One assistant at least is necessary, who takes his station on the opposite side of the pyrometer, to observe the levels, and keep them adjusted, by means of the double hook applied near the middle of the boiler, and represented in the section on the line TU, at the lowermost right-hand angle of the plate.

The pyrometer having been adjusted in the manner here described, by giving sufficient time for the standard prisms and

rod to contract to the true freezing temperature, as was easily known by the wires becoming perfectly fixed and stationary with regard to the marks; the ice was then removed from the copper trough; and the same being filled with water nearly on the boil, the ebullition was completed, and kept up, by means of the lamps now lighted for the purpose, and flipped in underneath.

The expansion, answering to the 180° between freezing and boiling, was now measured by working with the micrometer screw until the bisection * of its wire with those of the mark was again complete; the observer at the fixed microscope taking also especial care all the while to keep his bisection perfectly accurate. The number of revolutions, registered by the number of entire divisions that the zero of the circular scale had departed from its dart or index, and also the value of any fractional revolution, registered by the divisions on the head intercepted between zero and its proper dart, were then noted, as expressed in the first column of the subjoined table of experiments; which requires no other explanation than what is therein inserted, and which has been extended purposely to shew at one view, from inspection only, how much the length of our base would have been affected, if measured by these metals respectively, in temperatures between 32° and 62° .

All the experiments were repeated at least twice, and some of them three times, except the standard scale and glass pen-

* This bisection of the wires may always be made to a great degree of precision, by one with a tolerably good eye, and accustomed to observations of this sort. I have myself repeatedly adjusted the wires eight or ten times running, allowing another person to read off and unadjust each time, without the mean difference exceeding one-fourth of a division of the head, which is only $\frac{1}{64000}$ th part of an inch.

dulum rod, whose expansions were only tried once. The difference of a few divisions between the mean and extremes on the heat of 180° being, in things of this sort, of no importance, it was judged wholly unnecessary to aim at a greater degree of precision in repeating them oftener. By referring to the table, particularly that column containing the expansions on one foot by 180° , it will be perceived, that they are uniformly a small matter less than what has been assigned to the same metals respectively, in the experiments formerly alluded to.

Ultimate determination of the length of the Base on Hounslow-Heath.

In the former part of this paper, we have had occasion to speak of the seven first columns of the general table of the base; and the titles at the tops of the others respectively serve sufficiently to explain those towards the right-hand; the expansion of glass above, and its contraction below 62° , contained in the eleventh and twelfth columns, being deduced from the recent experiments with the pyrometer.

Feet.

The hypothenufal length of the base, as measured by 1369.925521 glass rods of twenty feet each + 4.31 feet, being the distance between the last rod and the center of the north-west pipe, has been shewn to be

-	-	-	27402.8204
---	---	---	------------

The reduction contained in the seventh column of the general table to be deducted is

.	.	.	0.0714
---	---	---	--------

Hence the apparent length of the base, reduced to the level of the south-east extremity, becomes

27402.7490

The

Fect.

The apparent length is to be augmented by the excess of the expansion above the contraction of the glass rods, contained in the thirteenth column of the general table = 4.1867 inches, reduced to the heat of 62°, as has been usually done in former operations of this nature

0.3489

The apparent length is farther to be augmented by the equation for 6° difference of temperature of the standard brass scale between 62° and 68°, this last being the heat in which the lengths of the glass rods were laid off = 20.3352 inches, as deduced from the experiments with the pyrometer

1.6946

Hence we have the correct length of the base in the temperature of 62° reduced to the level of the lowermost extremity near Hampton Poor-house;

27404.7925

This last length requires yet a small reduction for the height of this lowermost end above the mean level of the sea, supposed to be fifty-four feet, or nine fathoms,

0.0706

Hence the true or ultimate length of the base, reduced to the level of the sea, and making a portion of the mean circumference of the earth, becomes

27404.7219

As some small degree of uncertainty remains with regard to this last reduction, it may not be improper to say yet a few words on the principles that have been adhered to in making the computation. It will be remembered, that the measurement was made $3\frac{1}{2}$ feet above the surface of the heath, that being the height of the stands whereon the rods were placed; and

and that the telescopic spirit level gave a descent of 36.1 feet from the lowermost pipe to the surface of summer water in the Thames at Hampton. The accurate section of the river lately published, gives a fall of 13.33 feet from Hampton to the level of low water spring tides at Isleworth. Now these three being added together, we have nearly fifty-three feet for the height of the base above Isleworth. Having had no immediate means of determining what real difference there may be between Isleworth and low water spring tides at the mouth of the Thames (for instance at the Hope or the Nore), I have supposed that fall to be about seven feet, so as to make the total descent sixty feet. Now, supposing the spring tides at the Nore to rise eighteen feet, if, according to M. DE LA LANDE's method, we deduct one third of eighteen, *viz.* six feet from sixty, we shall have fifty-four feet, or nine fathoms, that the mean surface of the sea is below the measured base. Whether this conclusion be perfectly accurate or not is of no moment, since a whole fathom of difference (and I apprehend we are not farther from the truth) does not vary the reduction quite one-tenth of an inch. The reduced base has therefore been found by the following analogy: as the mean semi-diameter of the earth (supposed here to be 3492915 fathoms) augmented by nine fathoms, is to the mean semi-diameter, so is the measured base 27404.7925 to the reduced base 27404.7219 at the level of the sea. It will doubtless be allowed, that infinite pains have been taken in the field and otherwise, throughout the whole of this operation, to obtain a just conclusion; but as the most accurate measurement imaginable is still more liable to err in excess than in defect, we will throw away some useless decimals, and establish the ultimate length of the base at 27404 feet and seven-tenths.

General Table of the Base, shewing the relative heights of the Stations above the south-east Poor-house, the Reduction of the Hypothenufes, and the Correction for the Temperature whence the true length is obtained in the heat of 62°.

1	2	3				4		7	8	9		10		11
		Relative heights.				Reduction of the hypothenufes.	Number of rods, twenty feet each.			Temperature.		Correction		
		Ascent.		Descent.						Total ascent.		Observed mean of 60 therm.	Excess or defect from 62°.	
Sections.	N° of hypothenufes, 60 feet each.	Feet.	Feet.	Feet.	Feet.	Feet.	Feet.	Feet.	Feet.	Inches.	Inches.			
First or south-east section, between Hampton Poor-house and Hamworth Summer-house.	1	0.07	-	-	0.07		0.000012	29+	71.4	+ 9.4	+ 0.2909			
	2	1.855	-	-	1.925		0.002875	.925521	80.7	+ 18.7	+ 0.5801			
	3	-	-	1.855	0.07		0.002875	30	80.6	+ 18.6	+ 0.5770			
	4	2.745	-	-	2.815		0.006288	30	74.0	+ 12.0	+ 0.3722			
	5	2.92	-	-	5.735		0.007114	30	62.6	+ 0.6	+ 0.0186			
	6	0.76	-	-	6.495		0.000489	30	58.7	- 3.3	-			
	7	1.57	-	-	8.065		*0.000825	30	60.5	- 1.5	-			
	8	2.91	-	-	10.975		0.007065	30	63.3	+ 1.3	+ 0.0403			
	9	-	-	0.68	10.295		0.000393	30	64.1	+ 2.1	+ 0.0651			
	10	0.65	-	-	10.945		0.000360	30	66.6	+ 4.6	+ 0.1427			
	11	-	-	0.04	10.905		0.000009	30	70.4	+ 8.4	+ 0.2606			
	12	-	-	1.18	9.725		0.001168	30	69.9	+ 7.9	+ 0.2451			
	13	0.83	-	-	10.555	10.555	0.000581	30	62.7	+ 0.7	+ 0.0217			
Second or middle section, between Hanworth Summer-house and the north side of the Staines Road.	14	-	-	0.94	9.615		0.000745	30	60.7	- 1.3	-			
	15	0.42	-	-	10.035		0.000191	30	63.2	+ 1.2	+ 0.0372			
	16	-	-	1.63	8.405		0.002222	30	69.0	+ 7.0	+ 0.2171			
	17	0.28	-	-	8.685		0.000073	30	71.1	+ 9.1	+ 0.2823			
	18	4.16	-	-	12.845		0.014439	30	68.6	+ 6.6	+ 0.2047			
	19	-	-	0.44	12.405		0.000169	30	63.5	+ 1.5	+ 0.0465			
	20	0.19	-	-	12.595		0.000036	30	59.2	- 2.8	-			
	21	1.87	-	-	14.465		0.002922	30	56.2	- 5.8	-			
	22	0.73	-	-	15.195		0.000452	30	57.0	- 5.0	-			
	23	0.39	-	-	15.585		0.000135	30	64.1	+ 2.1	+ 0.0651			
	24	0.95	-	-	16.535		0.000760	30	64.3	+ 2.3	+ 0.0713			
	25	0.49	-	-	17.025		0.000208	30	62.5	+ 0.5	+ 0.0155			
	26	2.11	-	-	19.135	8.58	*0.000063	30	71.1	+ 9.1	+ 0.2823			
	Third or north-west section, between the north side of the Staines Road, and King's Arbour near Colnbrook Road.	27	-	-	0.71	18.425		*0.000214	30	70.5	+ 8.5	+ 0.2637		
28		0.245	-	-	18.67		0.000057	30	63.3	+ 1.3	+ 0.0403			
29		1.21	-	-	19.88		0.001228	30	59.2	- 2.8	-			
30		-	-	0.165	19.715		0.000028	30	66.2	+ 4.2	+ 0.1303			
31		0.14	-	-	19.855		0.000024	30	73.8	+ 11.8	+ 0.3660			
32		-	-	0.12	19.735		0.000019	30	77.6	+ 15.6	+ 0.4839			
33		-	-	0.14	19.595		0.000024	30	73.7	+ 11.7	+ 0.3629			
34		1.21	-	-	20.805		0.001228	30	68.8	+ 6.8	+ 0.2109			
35		1.405	-	-	22.21		0.001653	30	65.8	+ 3.8	+ 0.1179			
36		2.34	-	-	24.55		0.004571	30	65.5	+ 3.5	+ 0.1086			
37		-	-	1.085	23.465		0.000985	30	61.5	- 0.5	-			
38		0.47	-	-	23.935		0.000192	30	59.4	- 2.6	-			
39		0.525	-	-	24.46		0.000238	30	55.6	- 6.4	-			
40		1.265	-	-	25.725		0.001341	30	55.1	- 6.9	-			
41		1.18	-	-	26.905		0.001168	30	56.1	- 5.9	-			
42		-	-	0.19	26.715		0.000036	30	58.4	- 3.6	-			
43		1.565	-	-	28.28		0.002049	30	58.2	- 3.8	-			
44		1.485	-	-	29.765		0.001845	30	57.3	- 4.7	-			
45		0.24	-	-	30.005		0.000055	30	60.8	- 1.2	-			

outh-east extremity near Hampton
 'emperature of the Glafs Rods;

11	12	13	14
Correction for temperature.			Correct length of the base.
Infion e 62° pt. leng.	Contract. below 62° — appt. leng.	Difference.	
ies.	Inches.	Inches.	Feet.
2909			
5801			
5770			
3722			
0186			
	—0.1024		
	—0.0465		
0403			
0651			
1427			
2606			
2451			
0217			
	—0.0403		
0372			
2171			
2823			
2047			
0465			
	—0.0869		
	—0.1799		
	—0.1551		
0651			
0713			
0155			
.2823			
.2637			
.0403			
	—0.0869		
.1303			
.3660			
.4839			
.3629			
.2109			
.1179			
.1086			
	—0.0155		
	—0.0807		
	—0.1985		
	—0.2140		
	—0.1830		
	—0.1117		
	—0.1179		
	—0.1458		
	—0.0272		

Third or no- side of the S the Colnbro	44	-	0.19	28.73		0.000030	30	57.4	- 3.0	
	43	1.565	-	28.28		0.002049	30	58.2	- 3.8	
	44	1.485	-	29.765		0.001845	30	57.3	- 4.7	
	45	0.24	-	30.005		0.000055	30	60.8	- 1.2	
	46	1.26	-	31.265	12.130	0.001973	20	65.3	+ 3.3	+0.0682
	400 ft.									
		40.44	9.175	31.265	31.265	0.071401	1369+			+5.9890
						.925521				

Hypotenusal length of the base containing 1369.925521 glass rods of twenty feet each + 4.31 feet,
Reduction contained in the seventh column to be subtracted,

Total apparent length of the base reduced to the level of the fourth-east extremity,
Add to the apparent length the difference between the expansion of glass above, and the contraction of
contained in the thirteenth column = 4.1867 inches =
Add further to the apparent length the equation for 6° difference of temperature of the standard brass scale betw
68°, the heat in which the glass rods were laid off = 20.3352 inches, =

Correct length of the base in the temperature of 62°, reduced to the level of the lowermost extremity,
Reduction for the height of the lower end of the base above the mean level of the sea, supposed to be 54 feet

True length of the base reduced to the mean level of the sea,

	-0.1117		
	-0.1179		
	-0.1458		
.0682	-0.0372		
<hr/>			
.9890	-1.8023	+4.1867	
<hr/>			
			= 27402.8204
			0.0714
<hr/>			
tion of it below 62°			27402.7490
scale between 62° and			0.3489
			1.6946
<hr/>			
54 feet or 9 fathoms			= 27404.7925
			0.0706
<hr/>			
			= 27404.7219

Table

Table of the Expansions of Metals, deduced from experiment

Description of the Metal Rods put to experiment.	Revolutions and parts of the micrometer for the expansion on five feet.		Actual expansion in parts of inch by 180°, the revolution being divided by 32.06.		
	By 180°	By 1°.	On 5 feet.	On 1 foot.	On 100
	Rev.Pts.	Parts.	In.	In.	In.
Standard brass scale. { Supposed to be Hamburg plate brass; length 42.187 inches, or 3.568 feet; breadth 0.55 inch; thickness 0.25 inch; and weight 1 lb. 10½ oz. Its expansion was measured by 25.47 revolutions of the micrometer; wherefore that on five feet would have been measured by -	35.69	19. ³³ / ₁₀₀	0.111323	0.0222646	2.2264
English plate brass, in form of a rod. { Length five feet; breadth 0.9 inch; thickness 0.15 inch; and weight 2 lbs. 5½ oz. Difficult from its thinness to be kept free from warping, - - -	36.41	20. ³³ / ₁₀₀	0.113568	0.0227136	2.2713
English plate brass, in form of a trough. { Length five feet; breadth 1.4 inch; depth 1 inch; weight 8 lbs. 3 oz. Perfectly strong and straight, - - -	36.45	20. ³³ / ₁₀₀	0.113693	0.0227386	2.2738
Steel rod. { Length five feet; breadth 0.5 inch; thickness 0.3 inch; weight 2 lbs. 7½ oz. Made from the very same bar with the chain, - - -	22.02	12. ³³ / ₁₀₀	0.068684	0.0137368	1.3736
Cast iron prism. { Length five feet; each of its sides 1¼ inch; and weight 11 lbs. 9 oz. Cut from the same rod with the standard prisms of the pyrometer, - - -	21.34	11. ⁸⁶ / ₁₀₀	0.066563	0.0133126	1.3312
Glass tube. { Length five feet; ³ / ₁₀₀ ths inch diameter; weight 1 lb. 13½ oz. Drawn from the same pot of metal with the measuring rods, - - -	14.93	8. ³³ / ₁₀₀	0.046569	0.0093138	0.9313
Solid glass rod. { Length 40.44 inches, or 3.37 feet; mean diameter six-tenths of an inch; and weight 1 lb. 2 oz. It had been applied for several years to a clock. Its expansion was measured by 10.46 revolutions of the micrometer; wherefore that on five feet would have been measured by -	15.54	8. ⁶³ / ₁₀₀	0.048472	0.0096944	0.9694



Measurement of a Base on Hounslow-Heath.

Experiments made with the Microscopic Pyrometer in April 1785.

parts of an revolutions 6.	By 1° of FAHRENHEIT the expansion is						Bases of 27400 feet of these metals would expand.				
	On 100 ft.	On 1 foot.	10 feet.	100 feet.	400 feet.	600 feet.	1000 ft.	By 1°.	By 10°.	By 20°.	By 30°.
In.	In.	In.	In.	In.	In.	In.	In.	In.	In.	In.	In.
2.22646	0.0001237	0.001237	0.01237	0.04948	0.07422	0.1237	3.38938	33.8938	67.7876	101.6814	
2.27136	0.0001262	0.001262	0.01262	0.05048	0.07572	0.1262	3.45788	34.5788	69.1576	103.7364	
2.27386	0.0001263	0.001263	0.01263	0.05052	0.07578	0.1263	3.46062	34.6062	69.2124	103.8168	
1.37368	0.0000763	0.000763	0.00763	0.03052	0.04578	0.0763	2.09062	20.9062	41.8124	62.7186	
1.33126	0.0000740	0.000740	0.00740	0.02960	0.04440	0.0740	2.02760	20.2760	40.5520	60.8280	
0.93138	0.0000517	0.000517	0.00517	0.02068	0.03102	0.0517	1.41658	14.1658	28.3316	42.4974	
0.96944	0.0000539	0.000539	0.00539	0.02156	0.03234	0.0539	1.47686	14.7686	29.5372	44.3058	



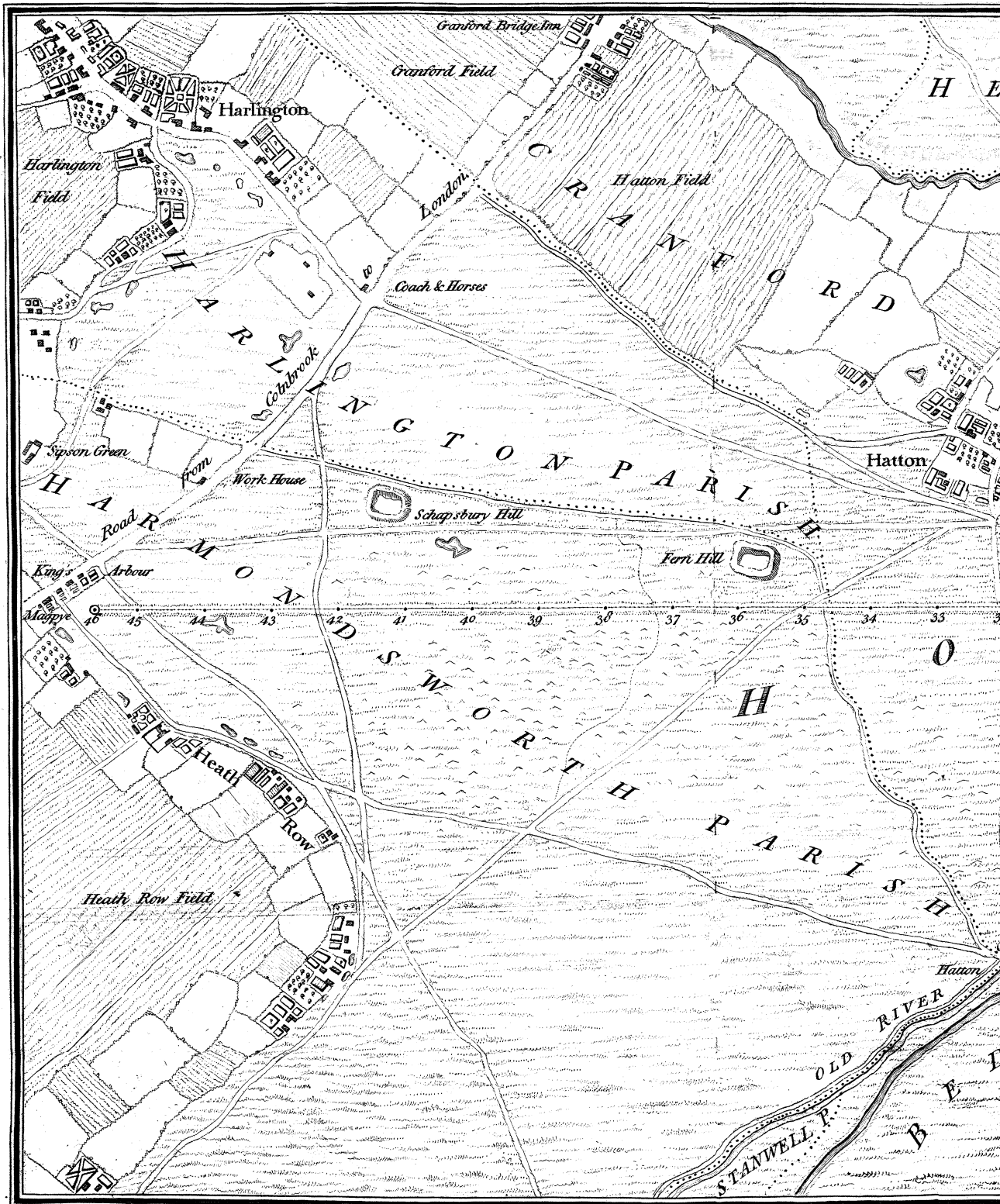

Scale of Two Miles.

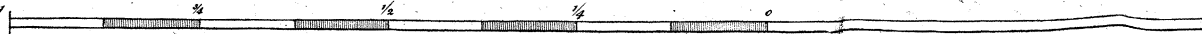

PLAN shewing the situation of the BASE measured

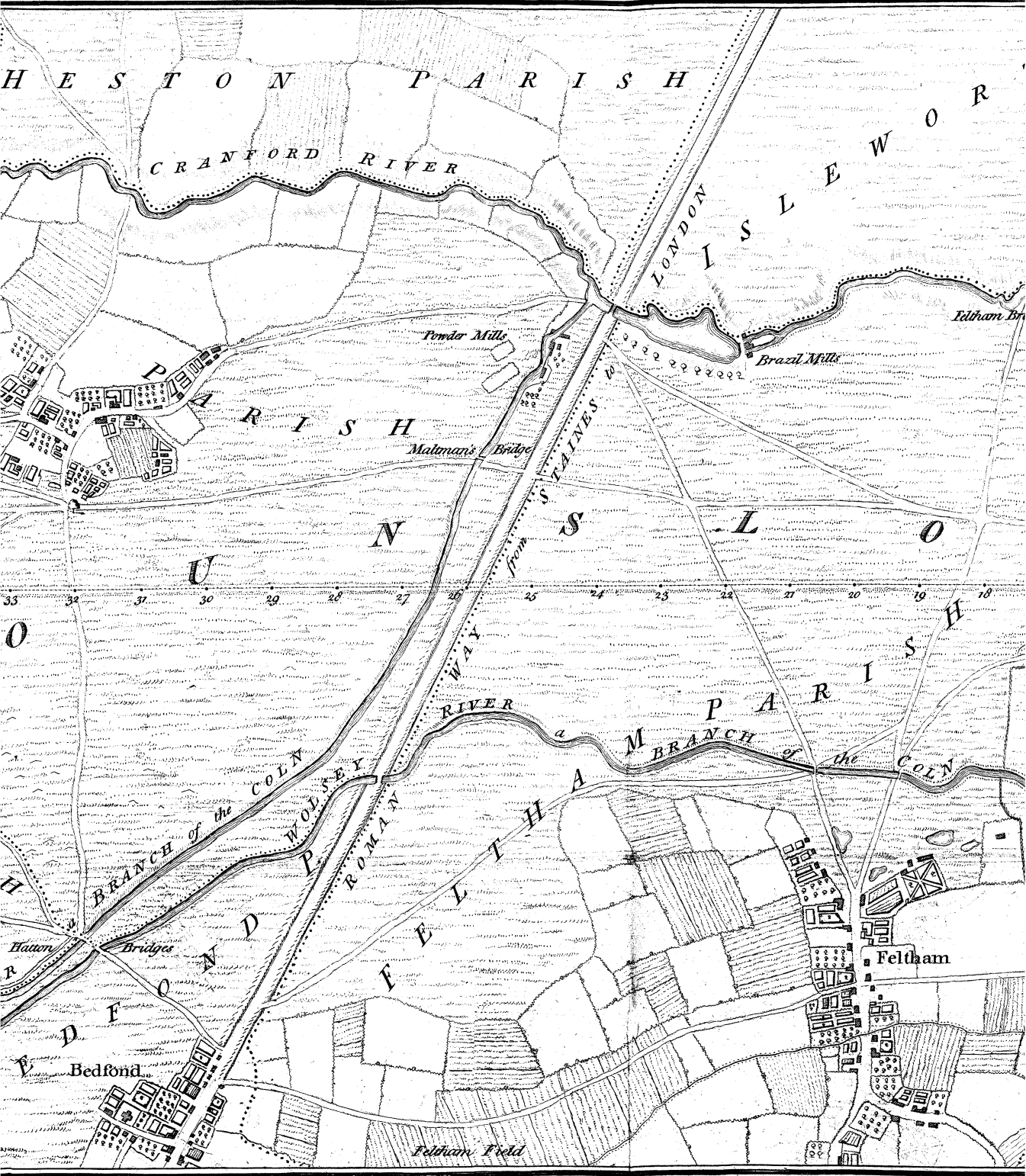

Map of HOUNSLOW HEATH in Summer 1784.

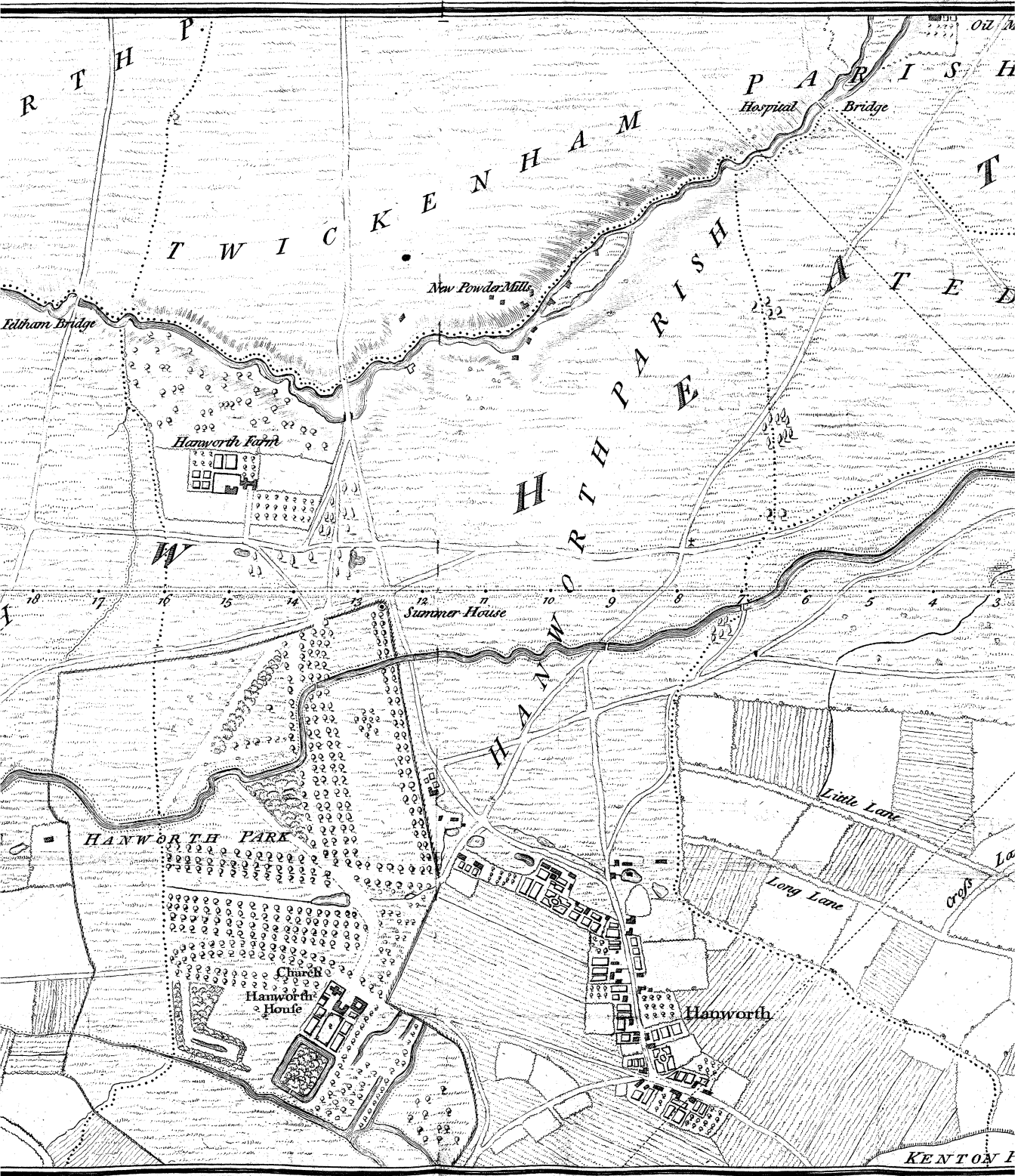

Scale of Feet.

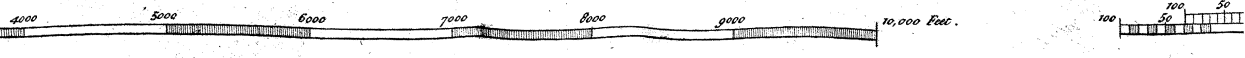

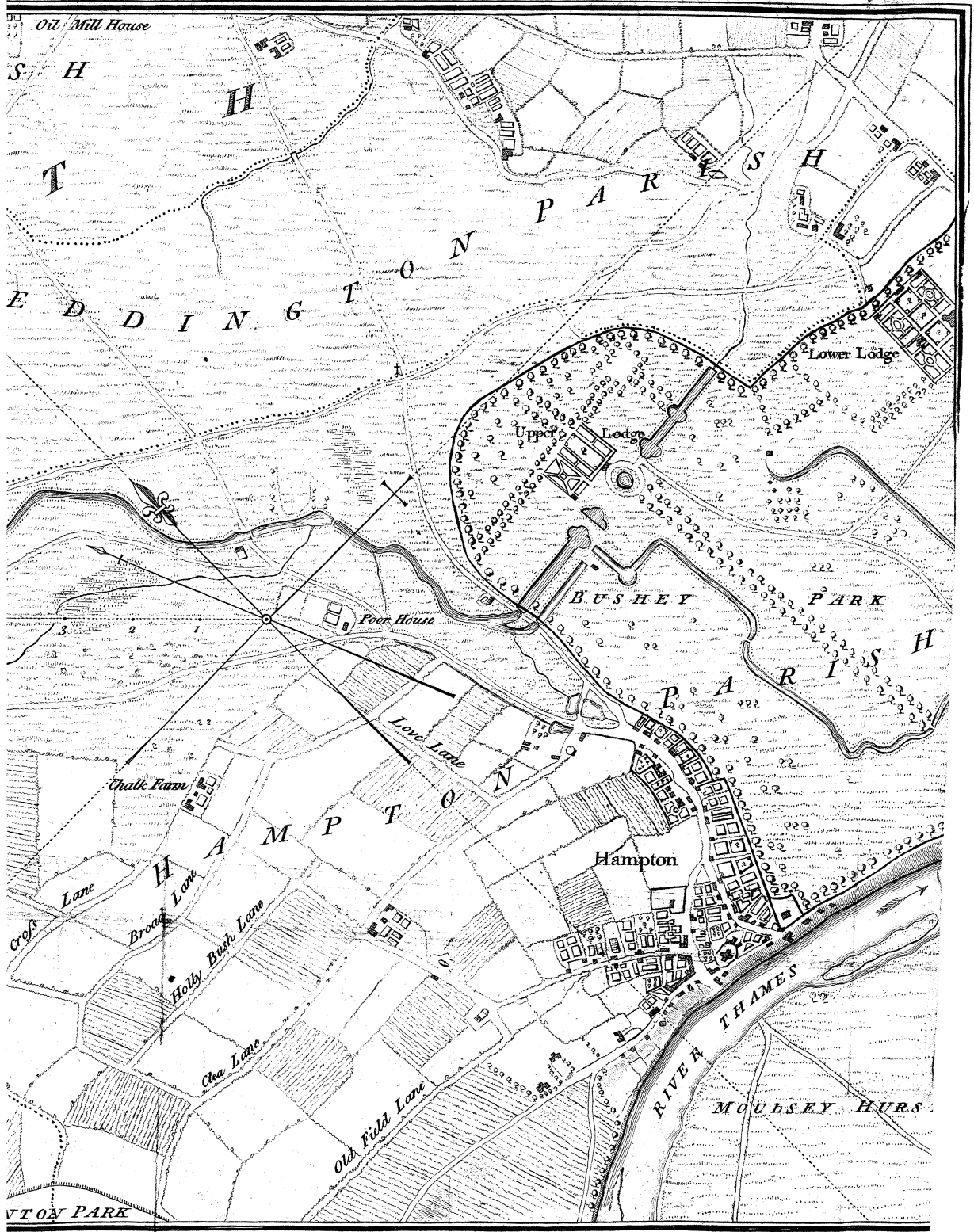

Scale of Fathoms & Toises.

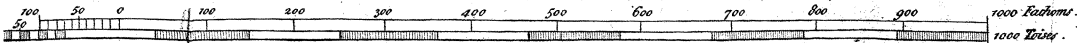

Ba

Holdfast for the 1st End
of the Chain.

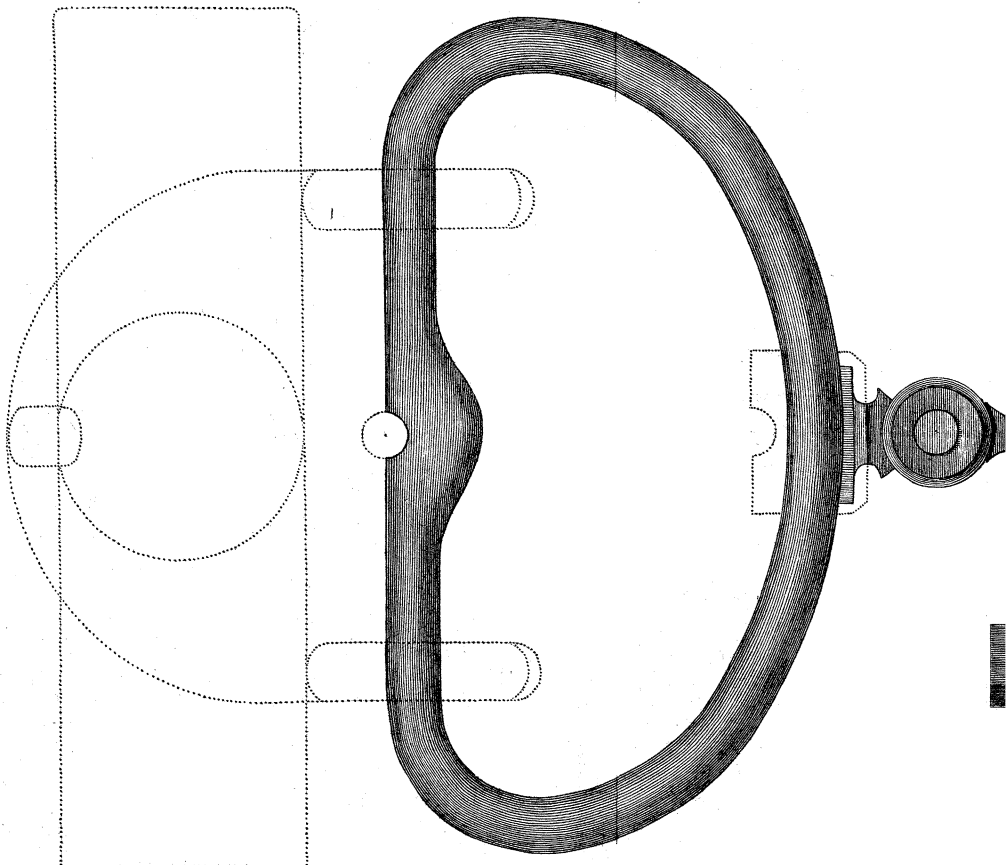
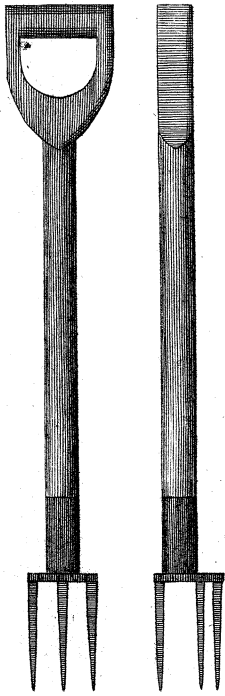

Disposition

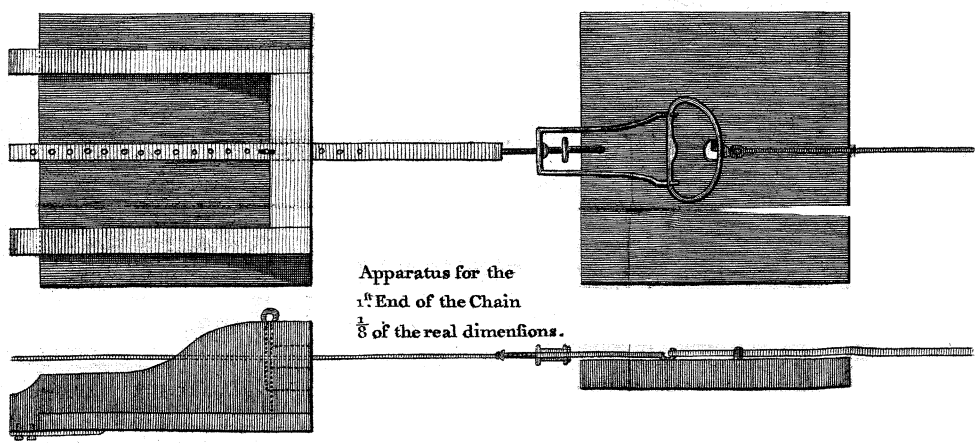
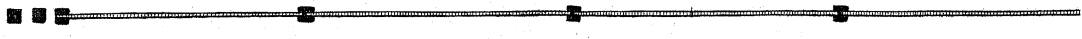

Apparatus for the
1st End of the Chain
 $\frac{1}{8}$ of the real dimensions.

Side Elevation of the

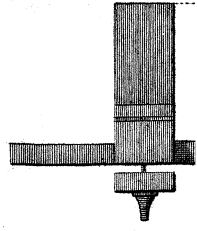

For the *DESCRIPTION* and *APPLICATION* of the

Plan of the 1st Link of the Chain in its original State.

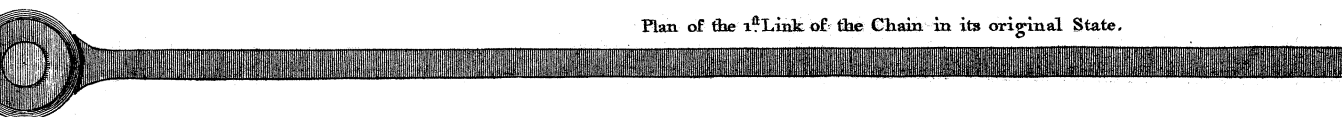

End piece of the 1st Link in its altered State.

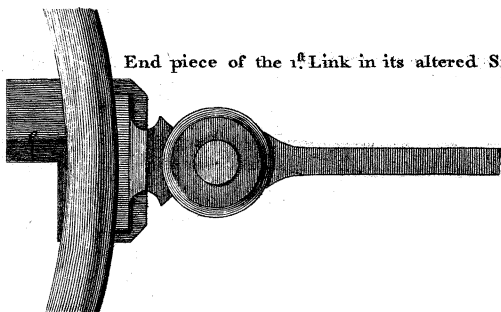

Plan of the Cross joint at every 10th Link.

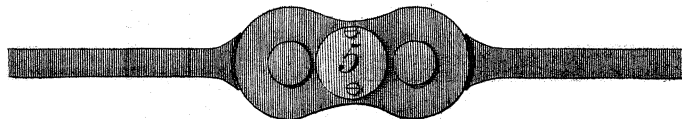

2 3 4 5 6 7 8

Elevation of the 1st Link in its original State.



Disposition of Seventeen Stands for the double Measurement with the Chain and Glass Rods.



Top of the Card Stand.

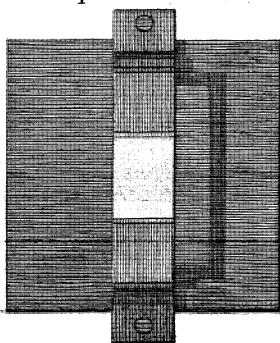

Side Elevation of the Card Stand.

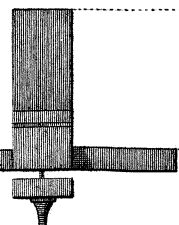

End Elevation of the Card Stand.

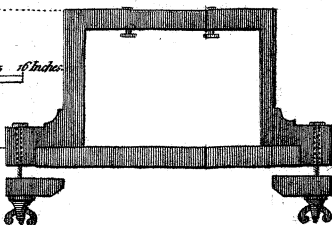

c 1 2 3 4 5 6 7 8 9 10 11 12 13 14 15 16 inches

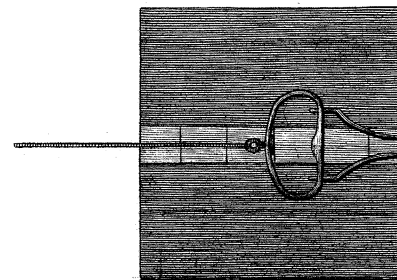

of the STEEL CHAIN.

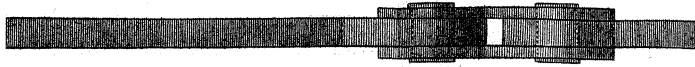

End piece of the last Link in its altered State.

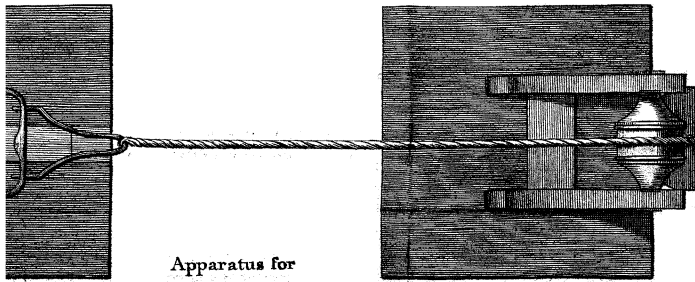
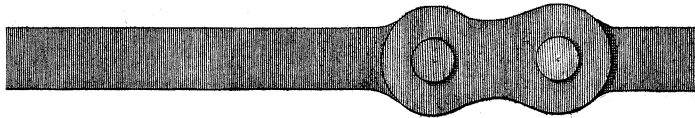
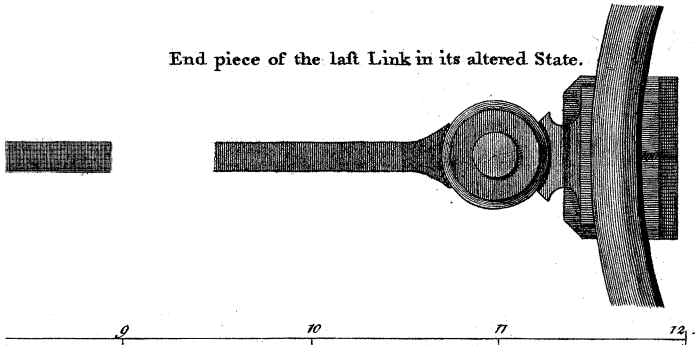

Apparatus for the last End of the Chain.

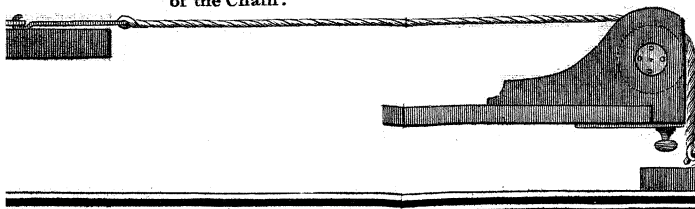

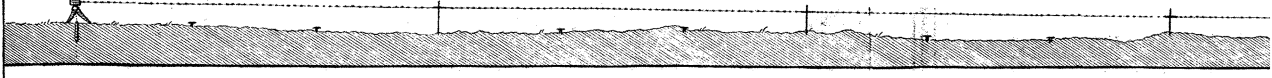

Subdivision

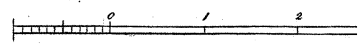
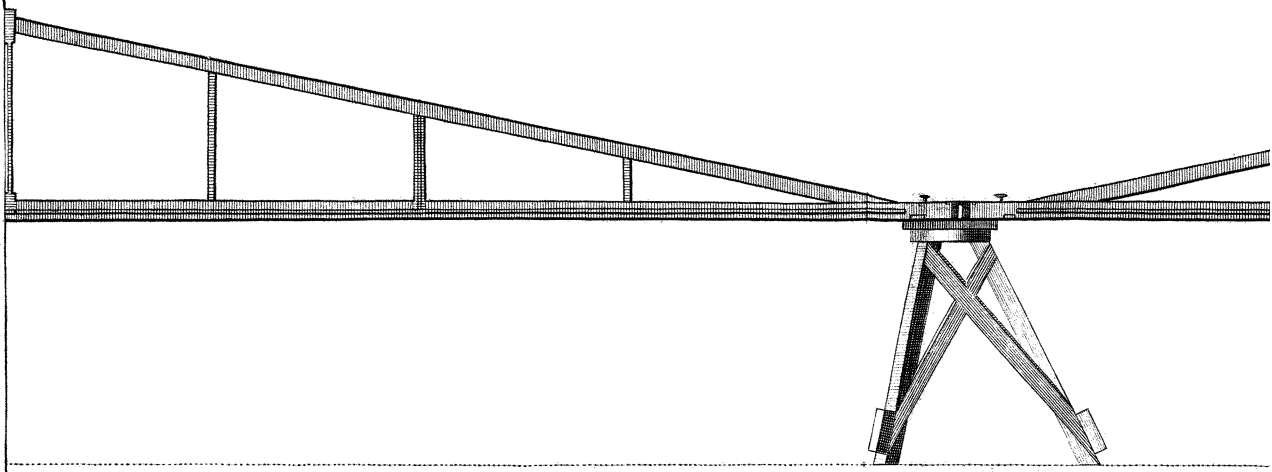

3^d or left-hand Rod.

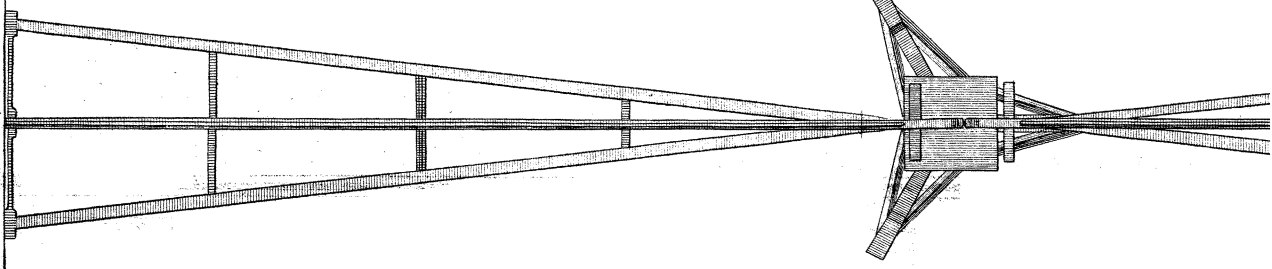

Section of the Pipe & Wheel terminating the Base.

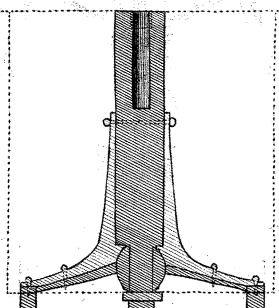

Plan

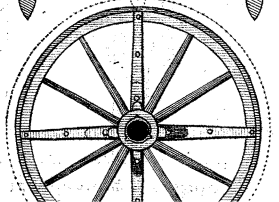

Elevation of the Ends of the Rods in Contact $\frac{1}{4}$ of the real dimen

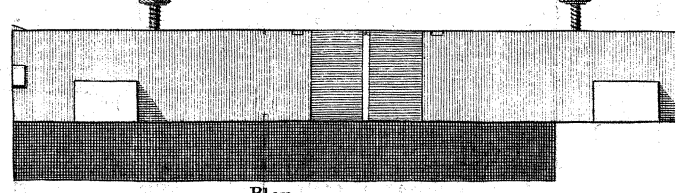

Plan

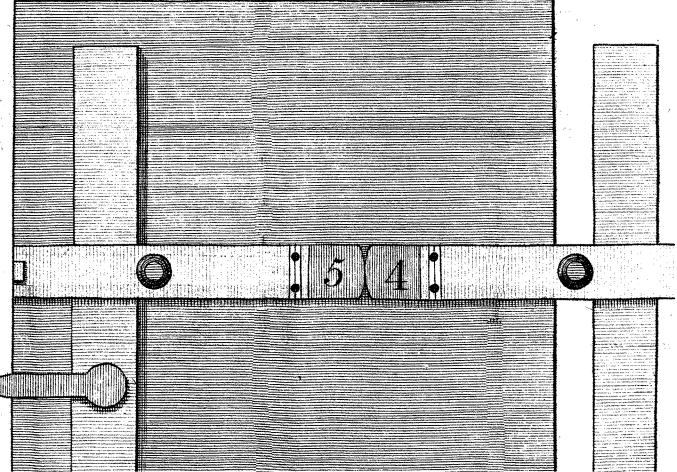

Vertical Clamp.

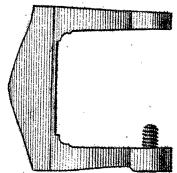

For the DESCRIPTION and APPLICATION of the DEAL RODS &c.

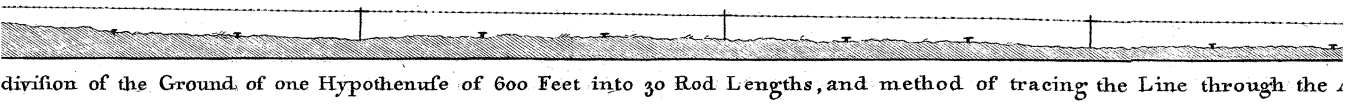

Division of the Ground of one Hypothenuse of 600 Feet into 30 Rod Lengths, and method of tracing the Line through the

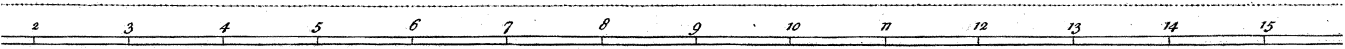
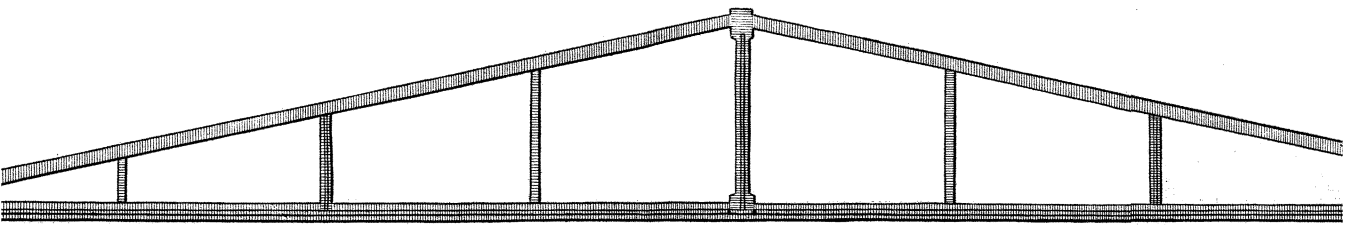

2^d or middle Rod .

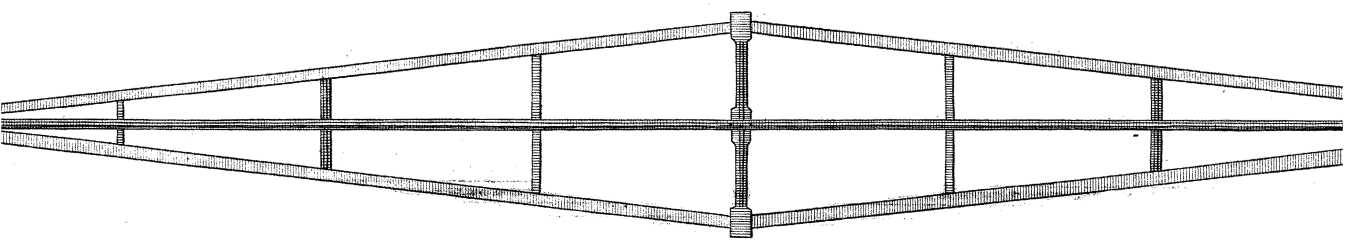

Real dimensions .



Elevation the Rods seen endwise .

Elevation of the Tripod .

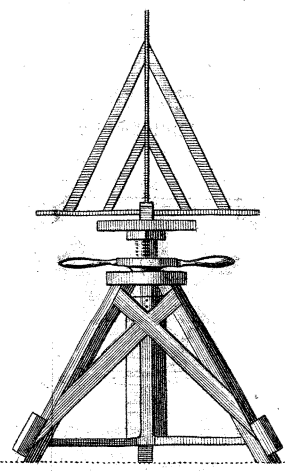
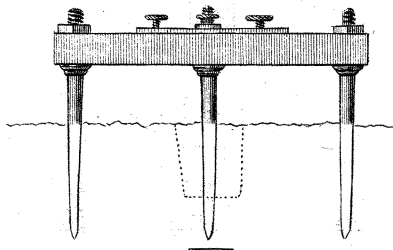

Boning Telescope .

Horizontal Clamp .

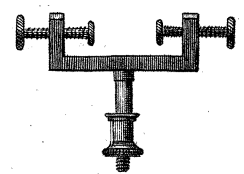

Plan of the Tripod .

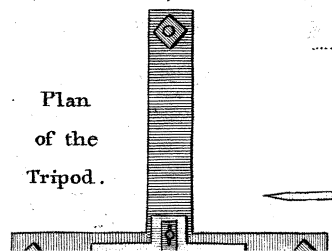
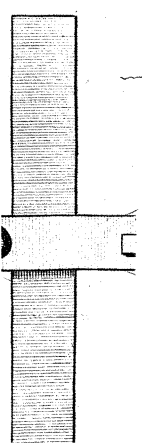

Boning Rod .

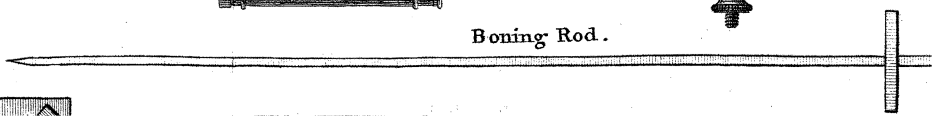

cc.

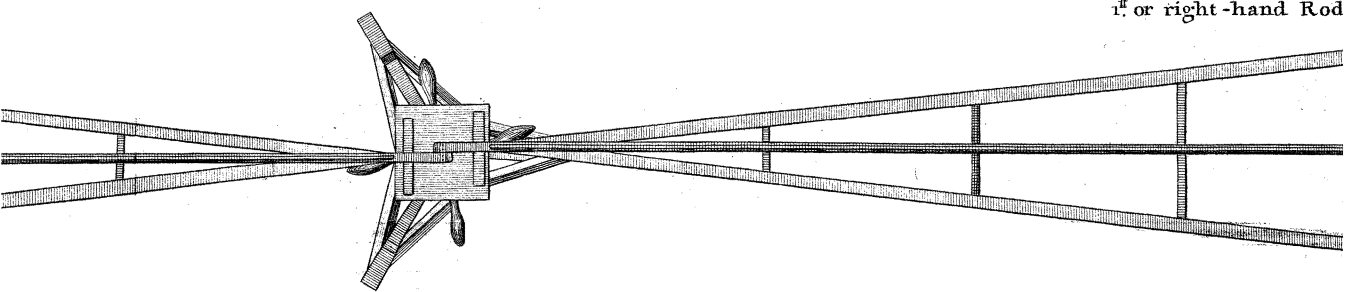
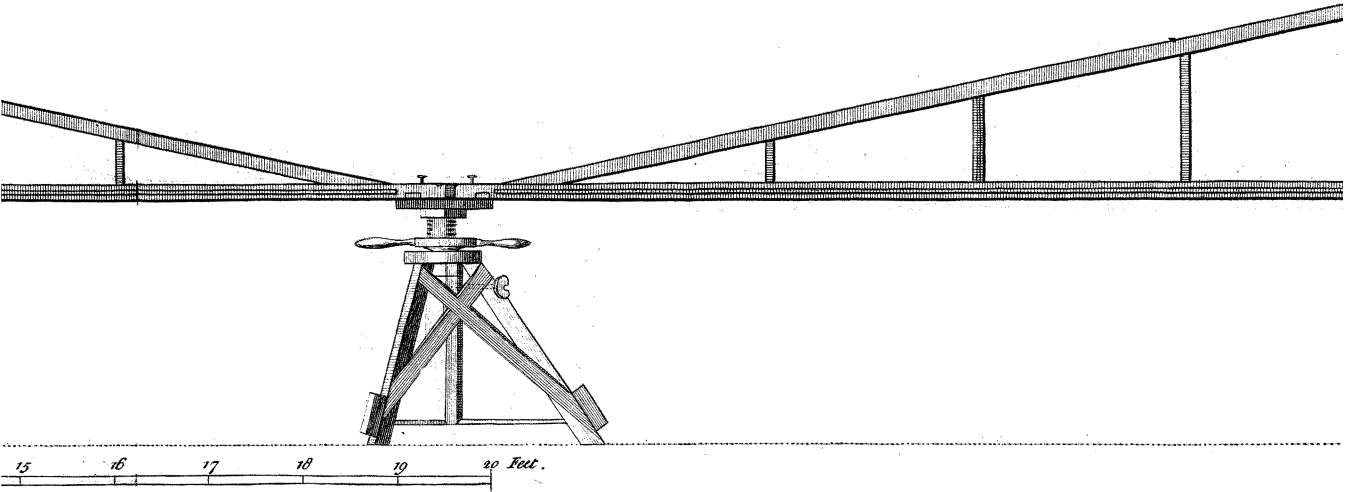

Elevation of the Ends of the Rods in Coincidence.

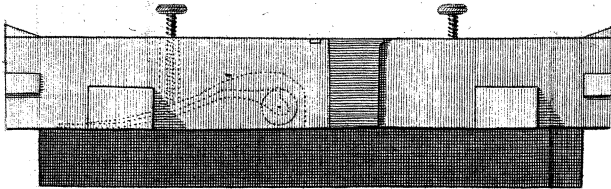

Plan

Plan of the Top of the Stand shewing the Groo for the horizontal Clamp $\frac{1}{4}$ of the real dimenf

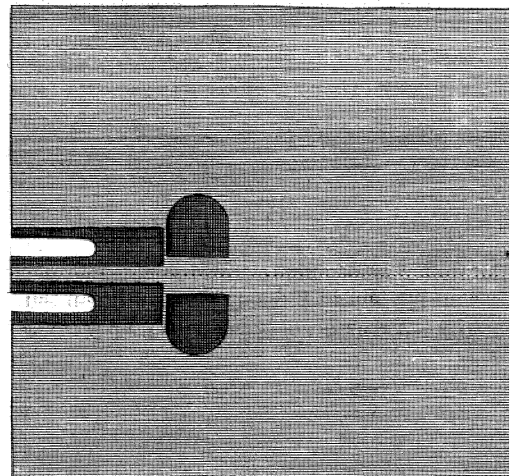
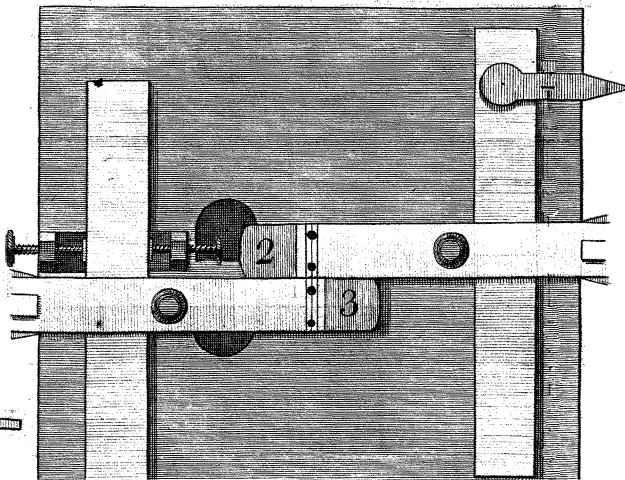

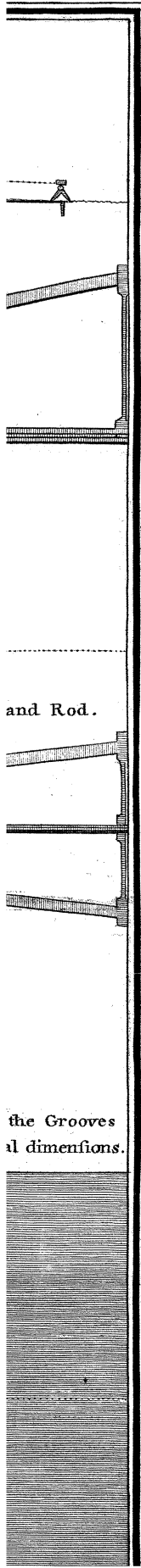

and Rod.

the Grooves
and dimensions.

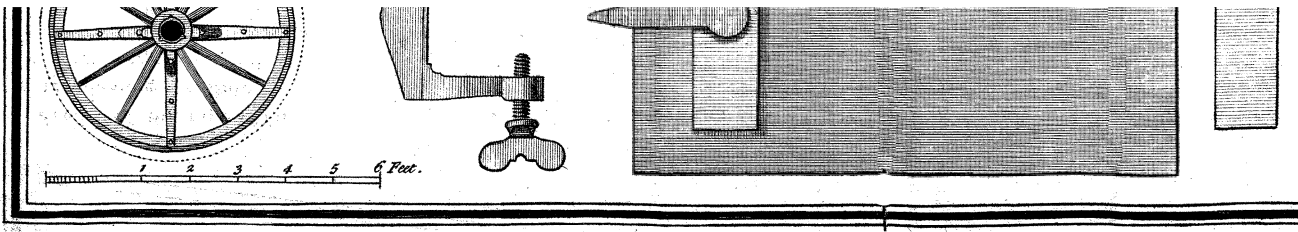

Tripod.

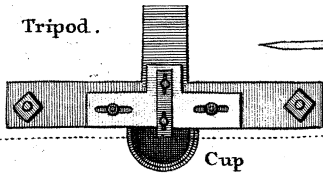

Cup

Boning Rod.

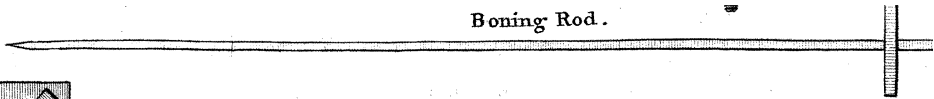

Painted Board.

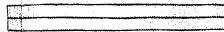

5 Feet.

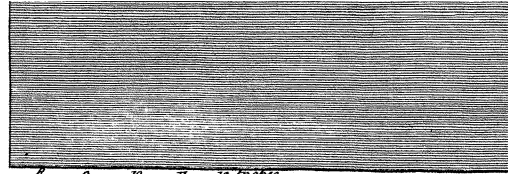
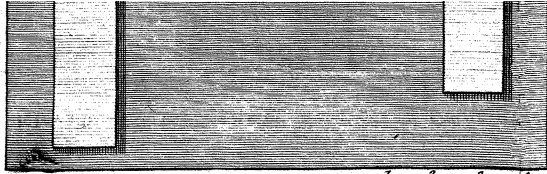
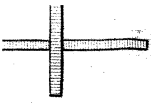

5. Fed.

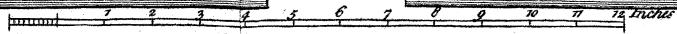

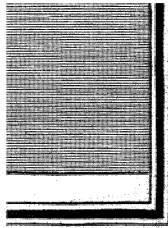

Basin. f.

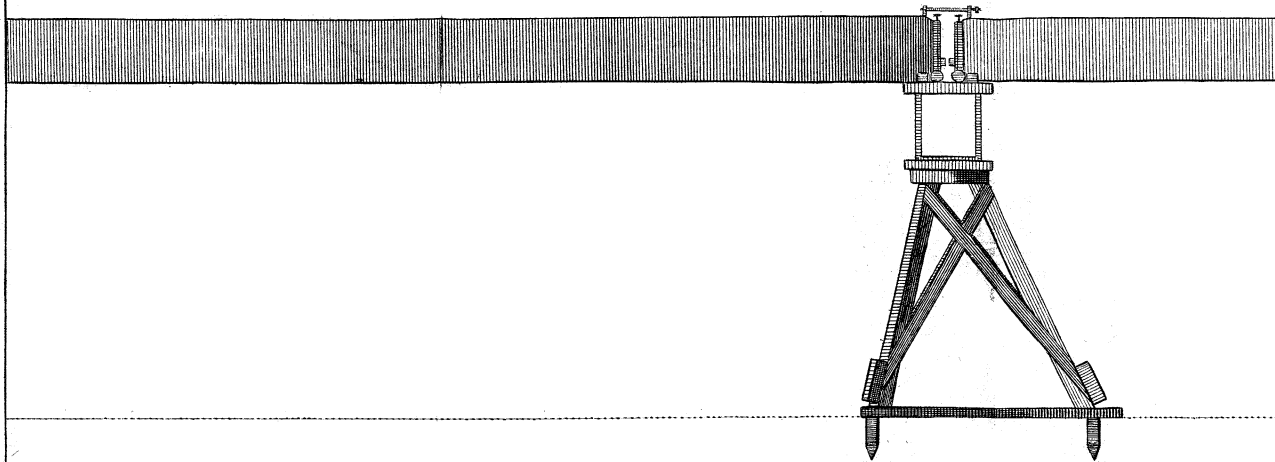

1st or left-hand Rod.

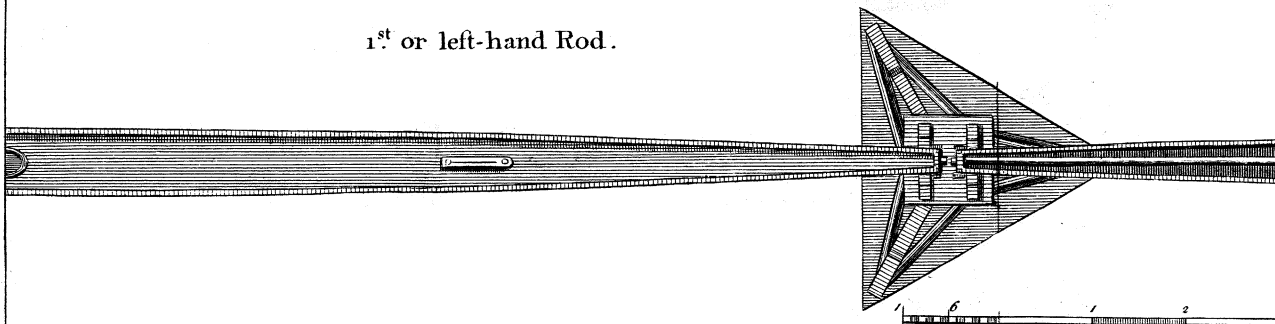

Longitudinal Elevation $\frac{1}{4}$ of the real dimensions.

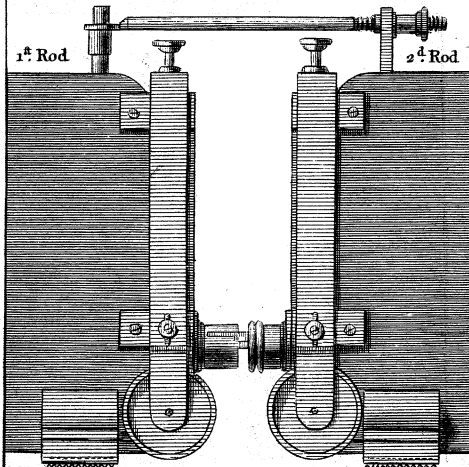

Front Elevation of the moveable End.

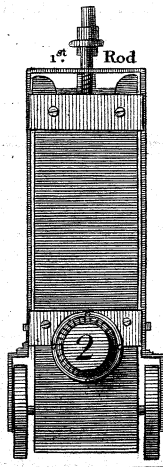

Longitudinal Section of the moveable End of the 1st 2^d Rod in their real dimensions.

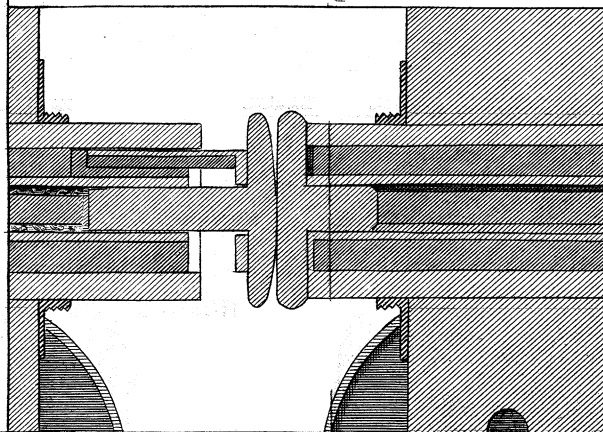

Plan

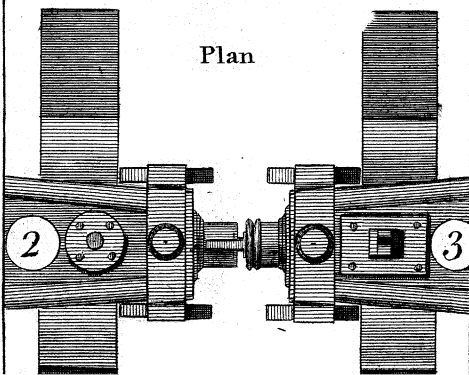

Plan

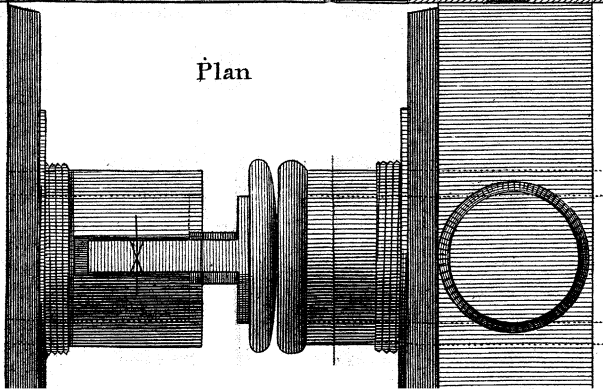

For the DESCRIPTION and APPLICATION of the GLASS RODS.

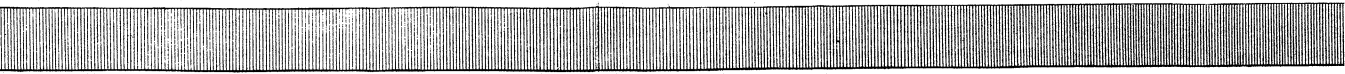

2^d or middle Rod .



Scale of Feet.

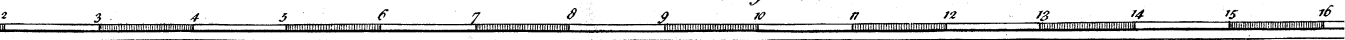

of the 1st Rod and fixed End of the

Section across the middle of the Rod
 $\frac{1}{4}$ of the real dimensions .

Longitudinal Section of the moveable
their real dimensions .

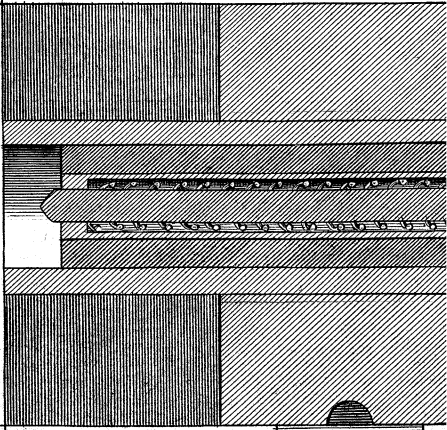
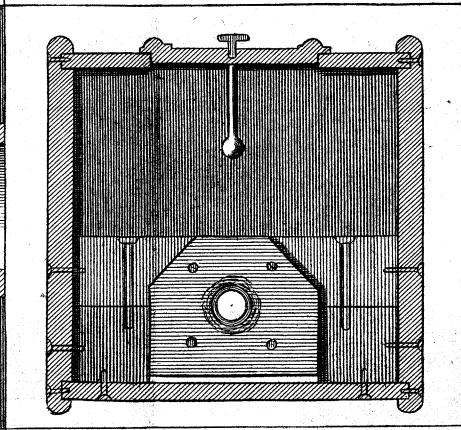
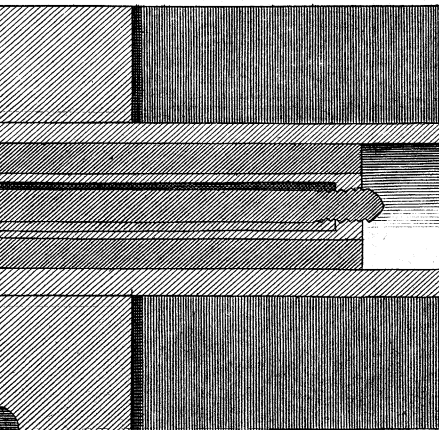

Scale of Inches for parts represented in $\frac{1}{4}$ of their real dimensions.

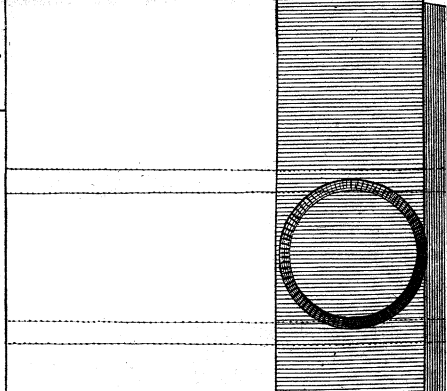
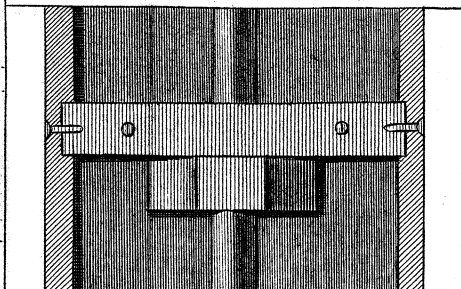

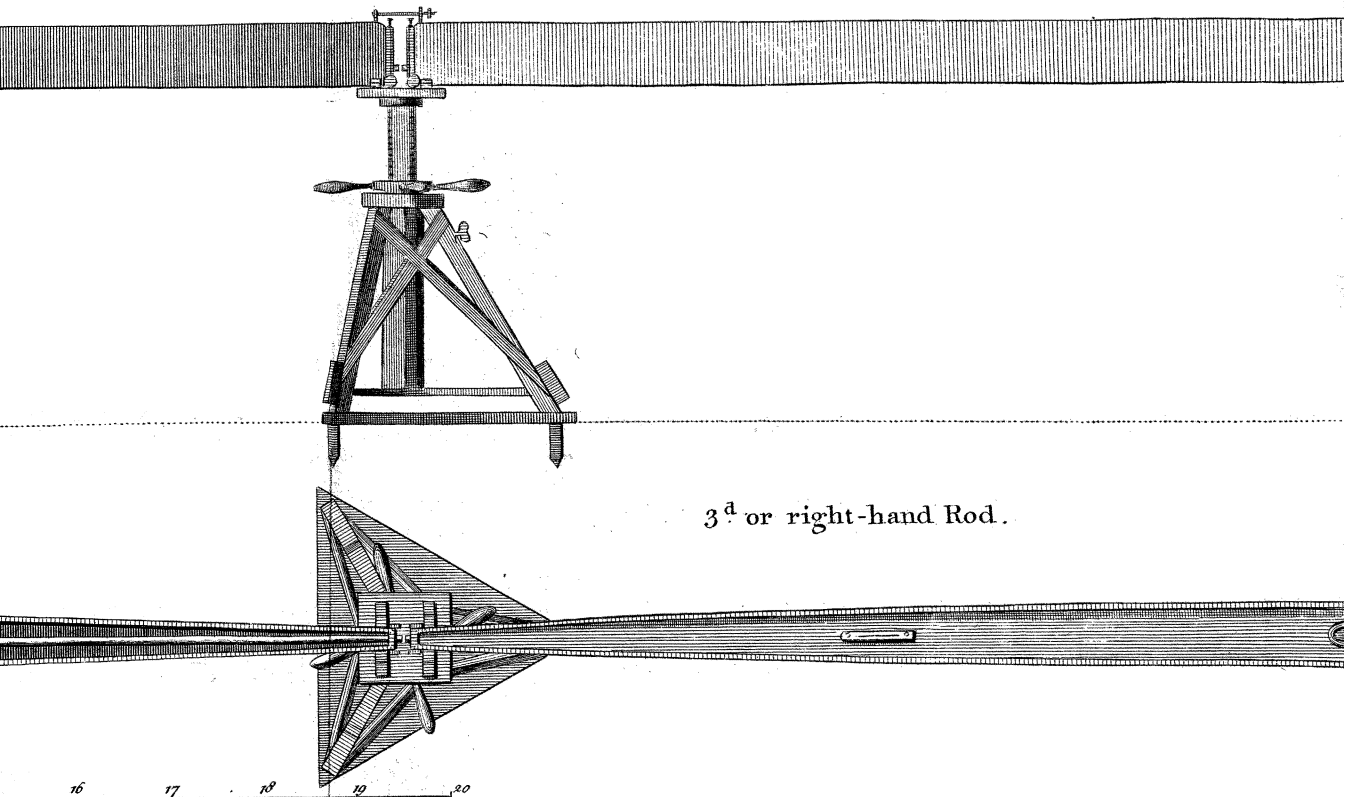

3^d or right-hand Rod.

moveable End of the 2^d Rod and fixed End of the 3^d Rod in

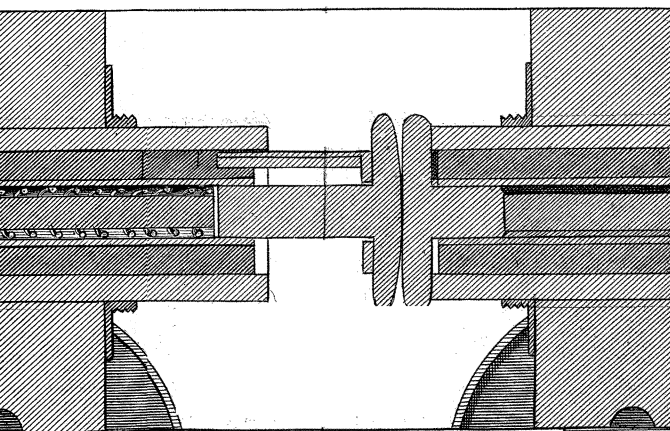

Front Elevation of the fixed End.

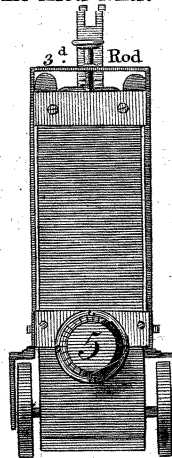

Longitudinal Elevation $\frac{1}{4}$ of the real dimensions.

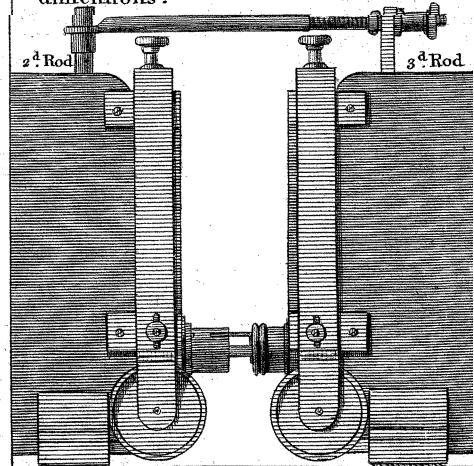

Plan

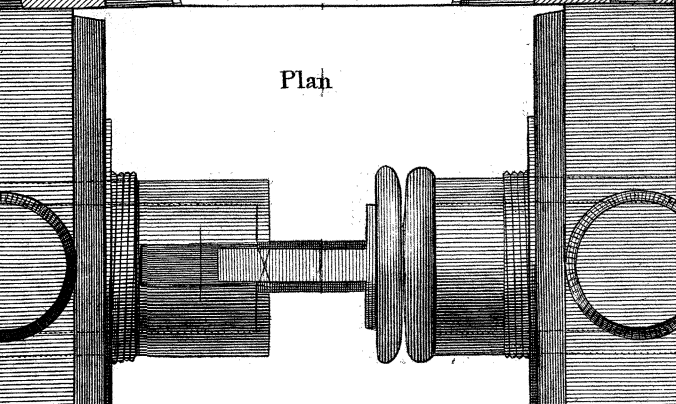

Plan

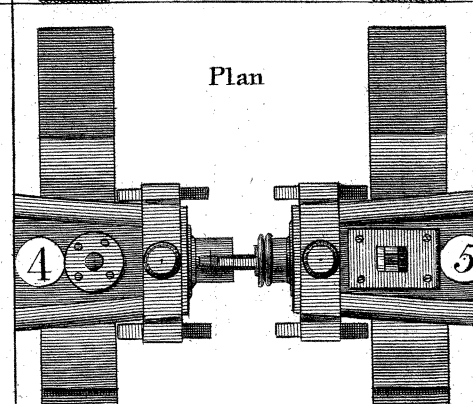

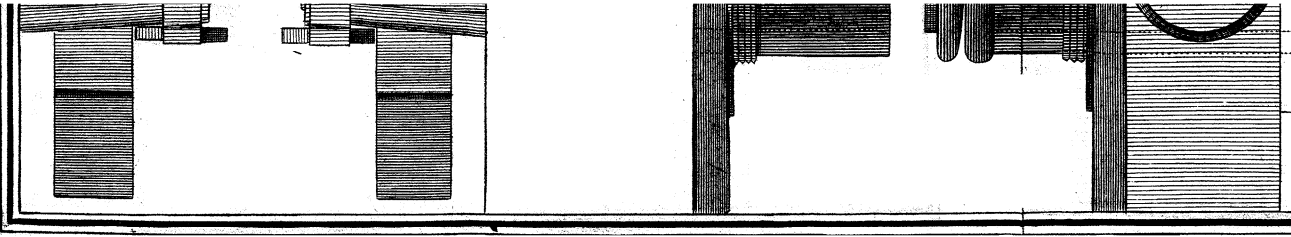

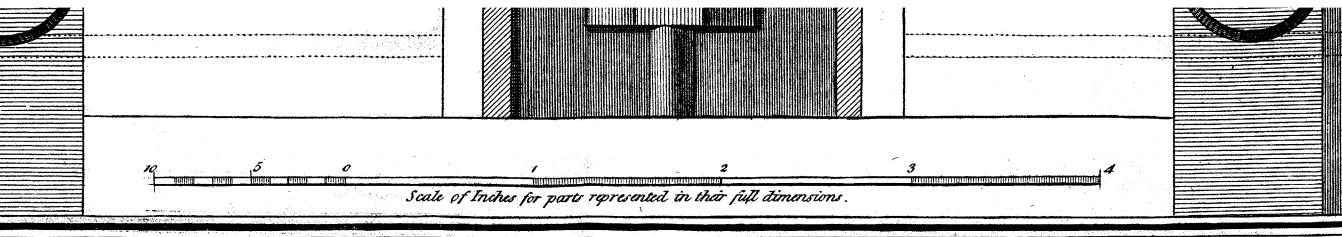

Scale of Inches for parts represented in their full dimensions.

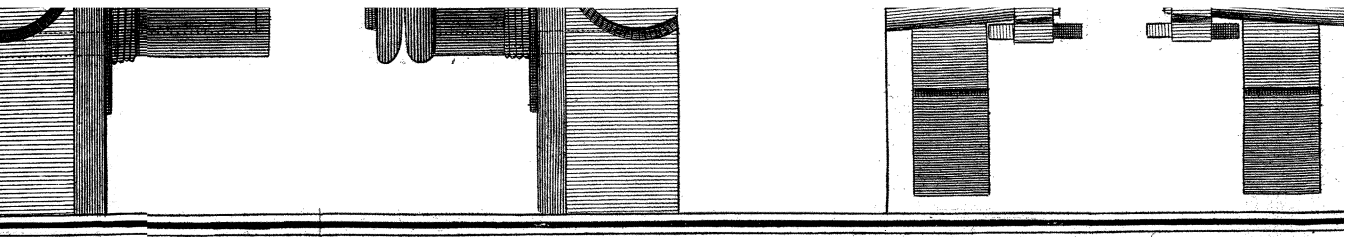

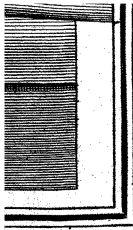

Barre sc.

Elevation of the Eye Piece Side.

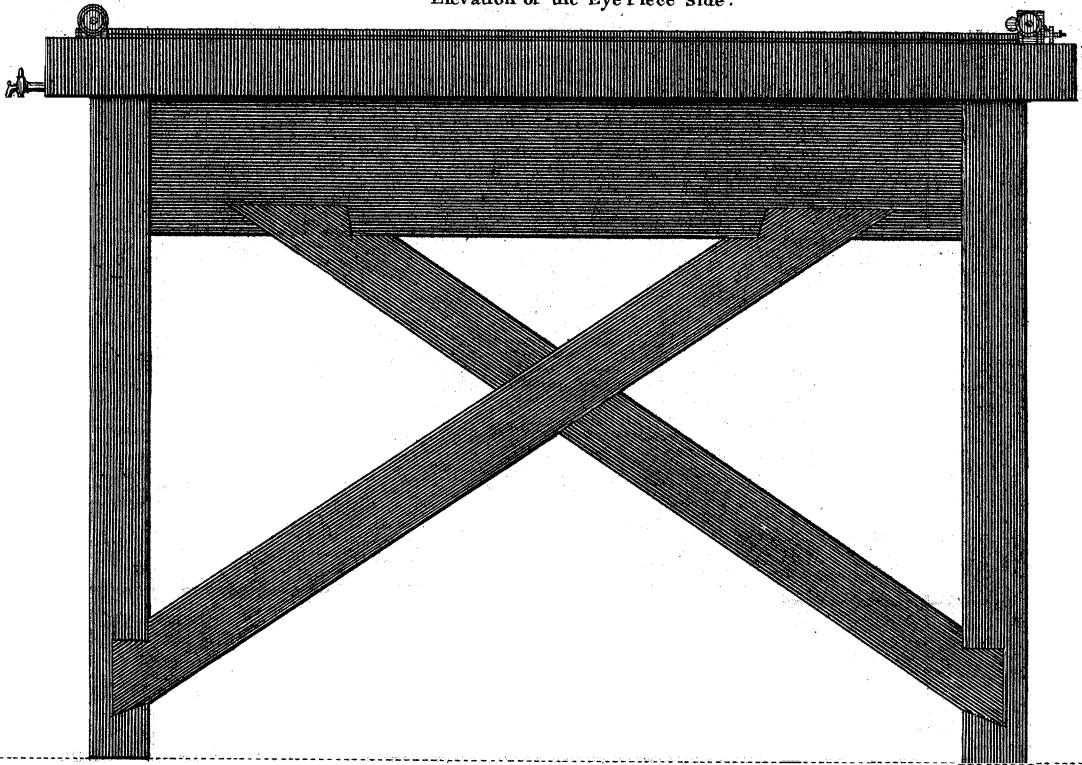

General Plan of the Top.

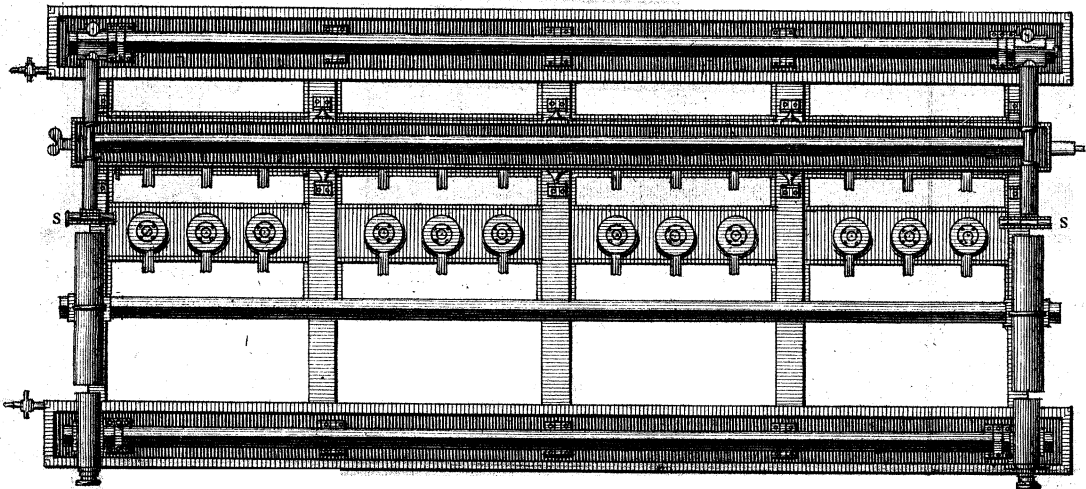

Scale to the General Plan and Elevations.

Elevation of the fixed end of the Boiler.

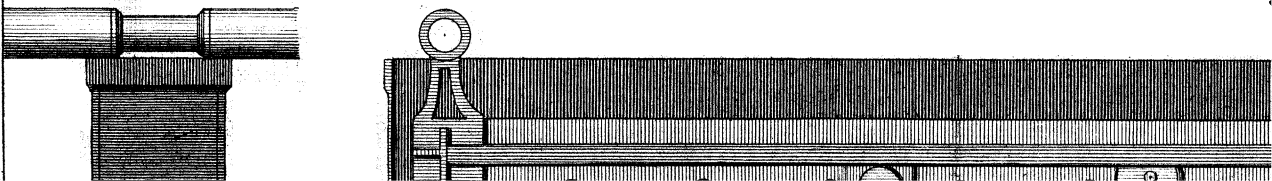

For the DESCRIPTION and USE of the MICROSCOPIC PYROMETER.

Elevation of the Micrometer End.

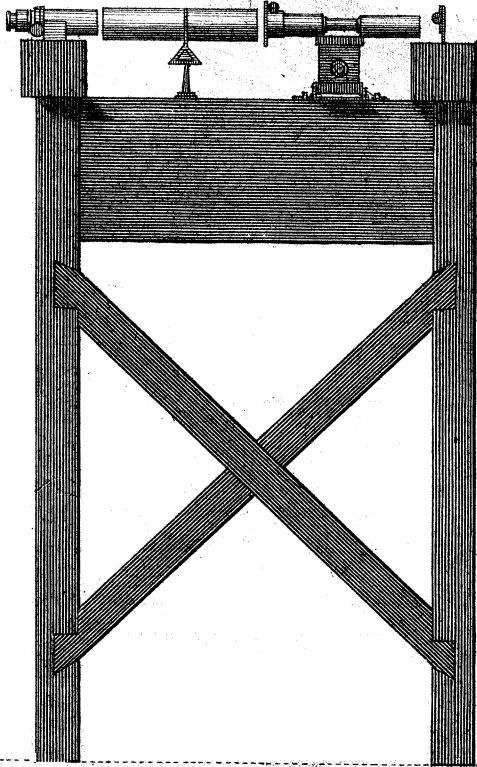

Angular View of the fixed End.

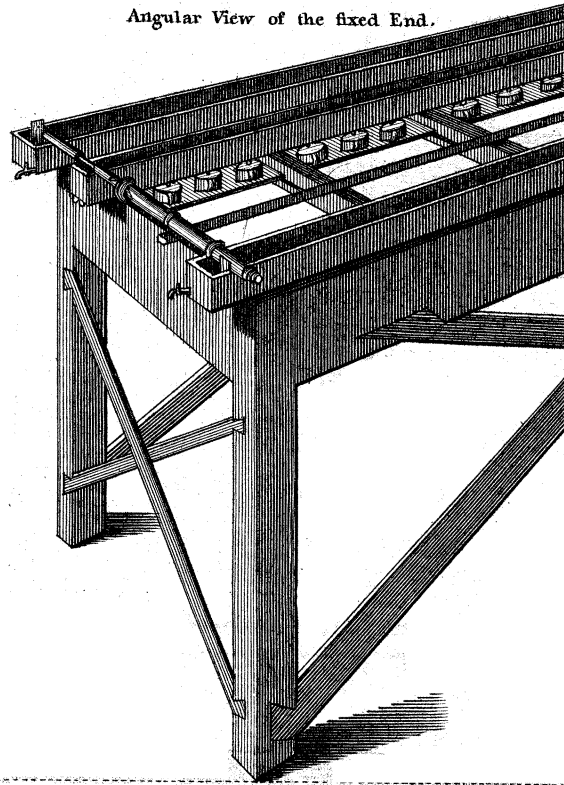

PLANS and ELEVATIONS of the MARKS and EYE-PIECES $\frac{1}{4}$ of the real size.

Fixed Microscope.

Micrometer Microscope

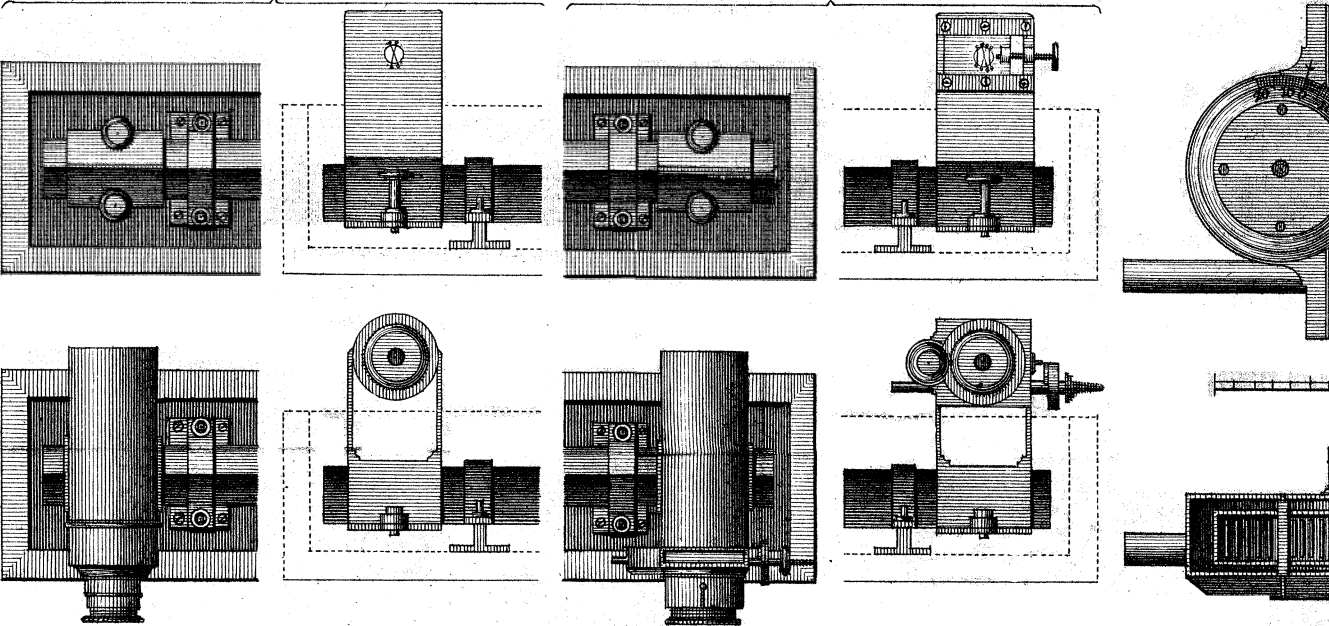

Longitudinal Section of the Boiler with its Slides and the Steel Rod as in experiment $\frac{1}{4}$ of the real size

2.

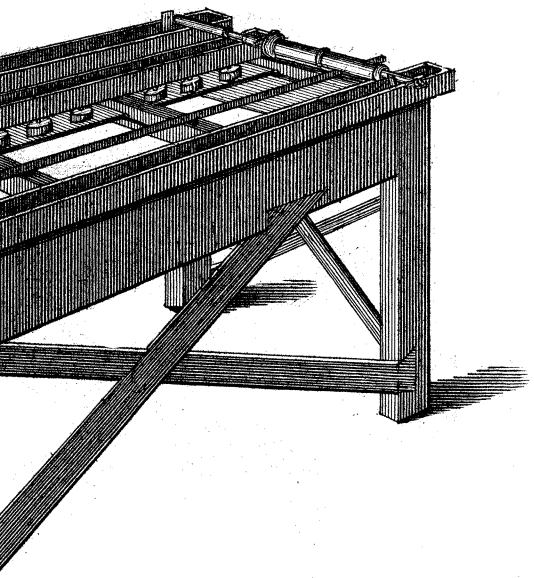

CONSTRUCTION of the MICROSCOPES.

Marks real size of the Apertures.

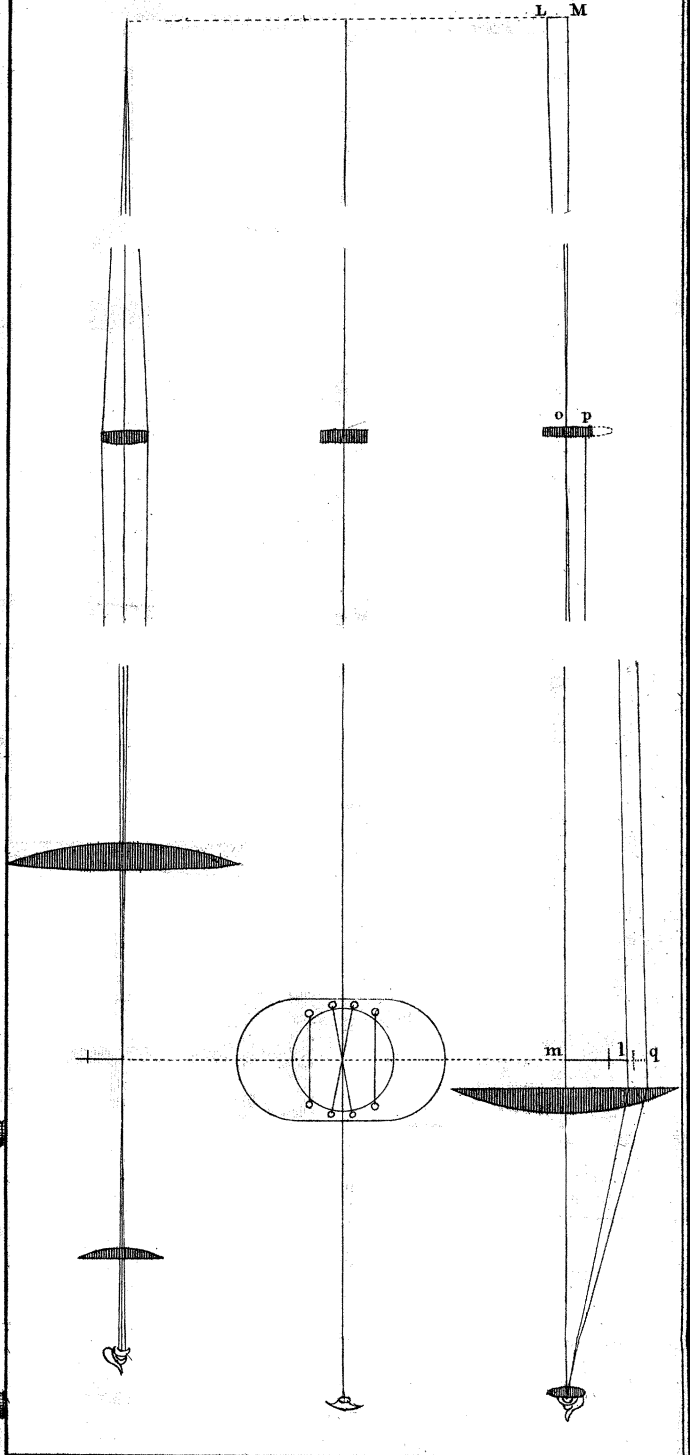

Elevation of the Micrometer full size.

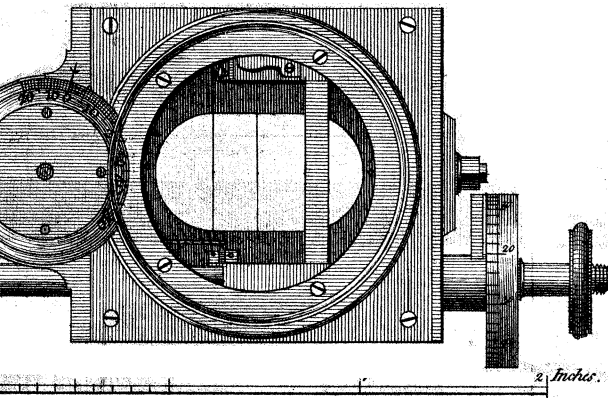

Horizontal Section of the Micrometer.

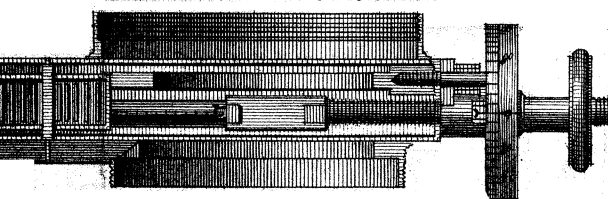

Elevation of the Spring End of the Boiler.

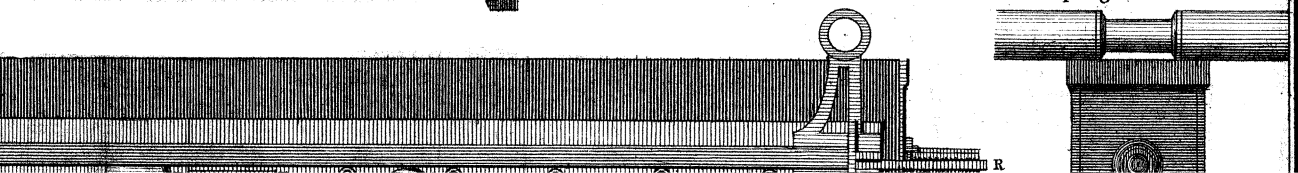

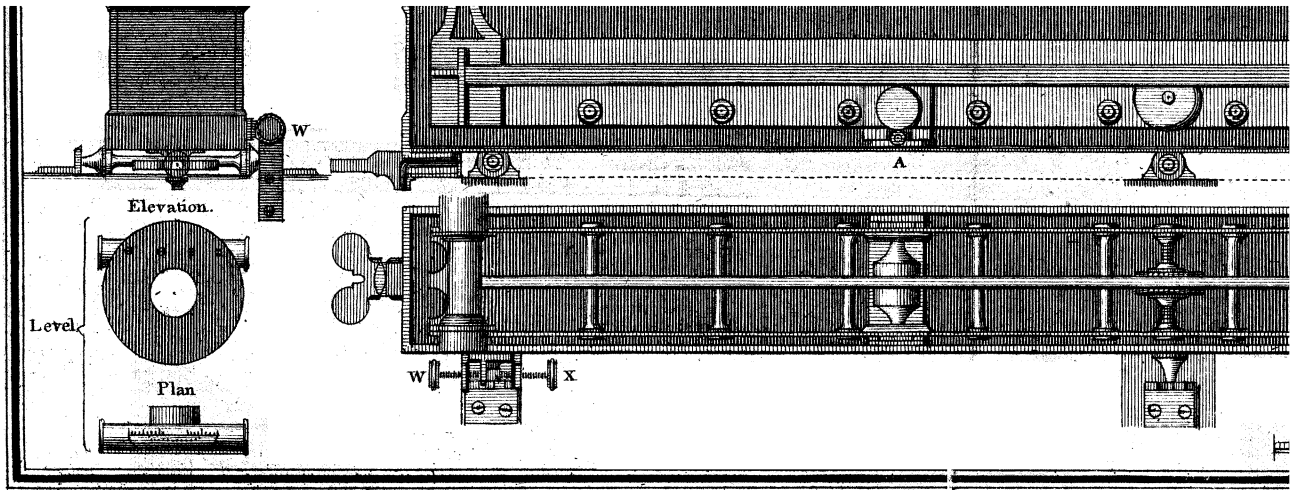

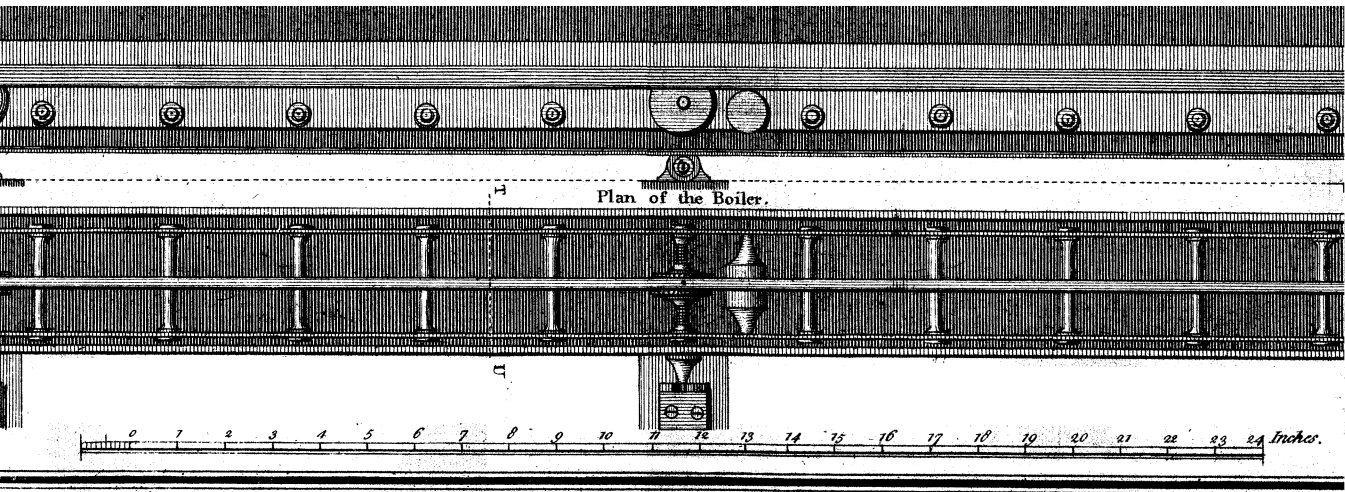

Plan of the Boiler.

0 1 2 3 4 5 6 7 8 9 10 11 12 13 14 15 16 17 18 19 20 21 22 23 24 inches.

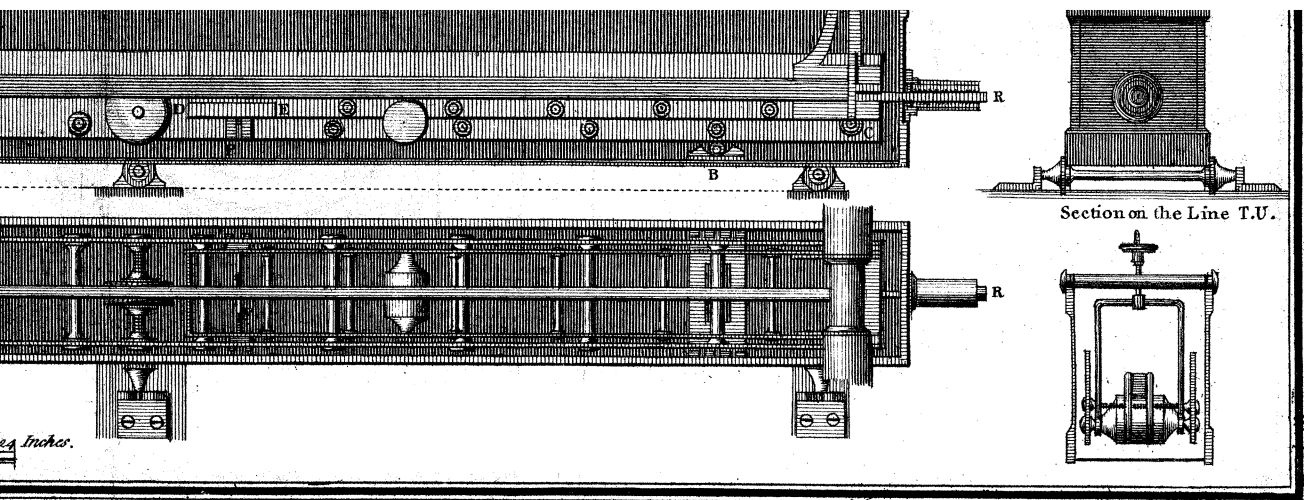

2 1/4 Inches.

Barre & Co.

General Table of the Base, shewing the relative heights of the Stations above the south-east extremity near Hampton Poor-house, the Reduction of the Hypothenuses, and the Correction for the Temperature of the Glass Rods; whence the true length is obtained in the heat of 62°.

1	2	3				6	7	8	9		10			13	14		
		Relative heights.							Reduction of the hypothenuses.	Number of rods, twenty feet each.	Temperature.		Correction for temperature.				
		Ascent.	Descent.	Total ascent.							Observed mean of 60 therm.	Excess or defect from 62°.	Expansion above 62° + appr. leng.			Contraction below 62° - appr. leng.	Difference.
Sections.	N° of hypothenuses, 600feeteach.	Feet.	Feet.	Feet.	Feet.	Feet.				Inches.	Inches.	Inches.	Feet.				
First or south-east section, between Hampton Poor-house and Hanworth Summer-house.	1	0.07	-	0.07		0.000012	29+	71.4	+ 9.4	+ 0.2909							
	2	1.855	-	1.925		0.002875	.925521	80.7	+ 18.7	+ 0.5801							
	3	-	1.855	0.07		0.002875	30	80.6	+ 18.6	+ 0.5770							
	4	2.745	-	2.815		0.006288	30	74.0	+ 12.0	+ 0.3722							
	5	2.92	-	5.735		0.007114	30	62.6	+ 0.6	+ 0.0186							
	6	0.76	-	6.495		0.000489	30	58.7	- 3.3			- 0.1024					
	7	1.57	-	8.065		*0.000825	30	60.5	- 1.5			- 0.0465					
	8	2.91	-	10.975		0.007065	30	63.3	+ 1.3	+ 0.0403							
	9	-	0.68	10.295		0.000393	30	64.1	+ 2.1	+ 0.0651							
	10	0.65	-	10.945		0.000360	30	66.6	+ 4.6	+ 0.1427							
	11	-	0.04	10.905		0.000009	30	70.4	+ 8.4	+ 0.2606							
	12	-	1.18	9.725		0.001168	30	69.9	+ 7.9	+ 0.2451							
	13	0.83	-	10.555	10.555	0.000581	30	62.7	+ 0.7	+ 0.0217							
Second or middle section, between Hanworth Summer-house and the north side of the Staines Road.	14	-	0.94	9.615		0.000745	30	60.7	- 1.3			- 0.0403					
	15	0.42	-	10.035		0.000191	30	63.2	+ 1.2	+ 0.0372							
	16	-	1.63	8.405		0.002222	30	69.0	+ 7.0	+ 0.2171							
	17	0.28	-	8.685		0.000073	30	71.1	+ 9.1	+ 0.2823							
	18	4.16	-	12.845		0.014439	30	68.6	+ 6.6	+ 0.2047							
	19	-	0.44	12.405		0.000169	30	63.5	+ 1.5	+ 0.0465							
	20	0.19	-	12.595		0.000036	30	59.2	- 2.8			- 0.0869					
	21	1.87	-	14.465		0.002922	30	56.2	- 5.8			- 0.1799					
	22	0.73	-	15.195		0.000452	30	57.0	- 5.0			- 0.1551					
	23	0.39	-	15.585		0.000135	30	64.1	+ 2.1	+ 0.0651							
Third or north-west section, between the north side of the Staines Road, and King's Arbour near the Colnbrook Road.	24	0.95	-	16.535		0.000760	30	64.3	+ 2.3	+ 0.0713							
	25	0.49	-	17.025		0.000208	30	62.5	+ 0.5	+ 0.0155							
	26	2.11	-	19.135	8.58	*0.000063	30	71.1	+ 9.1	+ 0.2823							
	27	-	0.71	18.425		*0.000214	30	70.5	+ 8.5	+ 0.2637							
	28	0.245	-	18.67		0.000057	30	63.3	+ 1.3	+ 0.0403							
	29	1.21	-	19.88		0.001228	30	59.2	- 2.8			- 0.0869					
	30	-	0.165	19.715		0.000028	30	66.2	+ 4.2	+ 0.1303							
	31	0.14	-	19.855		0.000024	30	73.8	+ 11.8	+ 0.3660							
	32	-	0.12	19.735		0.000019	30	77.6	+ 15.6	+ 0.4839							
	33	-	0.14	19.595		0.000024	30	73.7	+ 11.7	+ 0.3629							
	34	1.21	-	20.805		0.001228	30	68.8	+ 6.8	+ 0.2109							
	35	1.405	-	22.21		0.001653	30	65.8	+ 3.8	+ 0.1179							
	36	2.34	-	24.55		0.004571	30	65.5	+ 3.5	+ 0.1086							
37	-	1.085	23.465		0.000985	30	61.5	- 0.5			- 0.0155						
38	0.47	-	23.935		0.000192	30	59.4	- 2.6			- 0.0807						
39	0.525	-	24.46		0.000238	30	55.6	- 6.4			- 0.1985						
40	1.265	-	25.725		0.001341	30	55.1	- 6.9			- 0.2140						
41	1.18	-	26.905		0.001168	30	56.1	- 5.9			- 0.1830						
42	-	0.19	26.715		0.000036	30	58.4	- 3.6			- 0.1117						
43	1.565	-	28.28		0.002049	30	58.2	- 3.8			- 0.1179						
44	1.485	-	29.765		0.001845	30	57.3	- 4.7			- 0.1458						
45	0.24	-	30.005		0.000055	30	60.8	- 1.2			- 0.0372						
46	1.26	-	31.265	12.130	0.001973	20	65.3	+ 3.3	+ 0.0682								
	400 ft.																
		40.44	9.175	31.265	31.265	0.071401	1369+										
							.925521										
Hypothenusal length of the base containing 1369.925521 glass rods of twenty feet each + 4.31 feet,													27402.8204				
Reduction contained in the seventh column to be subtracted,													0.0714				
Total apparent length of the base reduced to the level of the south-east extremity,													27402.7490				
Add to the apparent length the difference between the expansion of glass above, and the contraction of it below 62°, contained in the thirteenth column = 4.1867 inches =													0.3489				
Add further to the apparent length the equation for 6° difference of temperature of the standard brass scale between 62° and 68°, the heat in which the glass rods were laid off = 20.3352 inches =													1.6946				
Correct length of the base in the temperature of 62°, reduced to the level of the lowermost extremity,													27404.7925				
Reduction for the height of the lower end of the base above the mean level of the sea, supposed to be 54 feet or 9 fathoms =													0.0706				
True length of the base reduced to the mean level of the sea,													27404.7219				

Table of the Expansions of Metals, deduced from experiments made with the Microscopic Pyrometer in April 1785.

Description of the Metal Rods put to experiment.	Revolutions and parts of the micrometer for the expansion on five feet.		Actual expansion in parts of an inch by 180°, the revolutions being divided by 32.06.			By 1° of FAHRENHEIT the expansion is						Bases of 27400 feet of these metals would expand.			
	By 180°	By 1°	On 5 feet.	On 1 foot.	On 100 ft.	On 1 foot.	10 feet.	100 feet.	400 feet.	600 feet.	1000 ft.	By 1°.	By 10°.	By 20°.	By 30°.
	Rev.Pts.	Parts.	In.	In.	In.	In.	In.	In.	In.	In.	In.	In.	In.	In.	In.
Standard brass scale. { Supposed to be Hamburg plate brass; length 2.187 inches, or 3.568 feet; breadth 0.55 inch; thickness 0.25 inch; and weight 1 lb. 10½ oz. Its expansion was measured by 25.47 revolutions of the micrometer; wherefore that on five feet would have been measured by -	35.69	19.⁹⁹⁹	0.111323	0.0222646	2.22646	0.0001237	0.001237	0.01237	0.04948	0.07422	0.1237	3.38938	33.8938	67.7876	101.6814
English plate brass, in form of a rod. { Length five feet; breadth 0.9 inch; thickness 0.15 inch; and weight 2 lbs. 5½ oz. Difficult from its thinness to be kept free from warping,	36.41	20.⁹⁹⁹	0.113568	0.0227136	2.27136	0.0001262	0.001262	0.01262	0.05048	0.07572	0.1262	3.45788	34.5788	69.1576	103.7364
English plate brass, in form of a trough. { Length five feet; breadth 1.4 inch; depth 1 inch; weight 8 lbs. 3 oz. Perfectly strong and straight,	36.45	20.⁹⁹⁹	0.113693	0.0227386	2.27386	0.0001263	0.001263	0.01263	0.05052	0.07578	0.1263	3.46062	34.6062	69.2124	103.8168
Steel rod. { Length five feet; breadth 0.5 inch; thickness 0.3 inch; weight 2 lbs. 7½ oz. Made from the very same bar with the chain,	22.02	12.⁹⁹⁹	0.068684	0.0137368	1.37368	0.0000763	0.000763	0.00763	0.03052	0.04578	0.0763	2.09062	20.9062	41.8124	62.7186
Cast iron prism. { Length five feet; each of its sides 1¼ inch; and weight 11 lbs. 9 oz. Cut from the same rod with the standard prisms of the pyrometer,	21.34	11.⁹⁹⁹	0.066563	0.0133126	1.33126	0.0000740	0.000740	0.00740	0.02960	0.04440	0.0740	2.02760	20.2760	40.5520	60.8280
Glass tube. { Length five feet; ⅜ths inch diameter; weight 1 lb. 13½ oz. Drawn from the same pot of metal with the measuring rods,	14.93	8.⁹⁹⁹	0.046569	0.0093138	0.93138	0.0000517	0.000517	0.00517	0.02068	0.03102	0.0517	1.41658	14.1658	28.3316	42.4974
Solid glass rod. { Length 40.44 inches, or 3.37 feet; mean diameter six-tenths of an inch; and weight 1 lb. 2 oz. It had been applied for several years to a clock. Its expansion was measured by 10.46 revolutions of the micrometer; wherefore that on five feet would have been measured by -	15.54	8.⁹⁹⁹	0.048472	0.0096944	0.96944	0.0000539	0.000539	0.00539	0.02156	0.03234	0.0539	1.47686	14.7686	29.5372	44.3058



PLAN shewing the situation of the BASE measured on HOUNSLOW HEATH in Summer 1784.

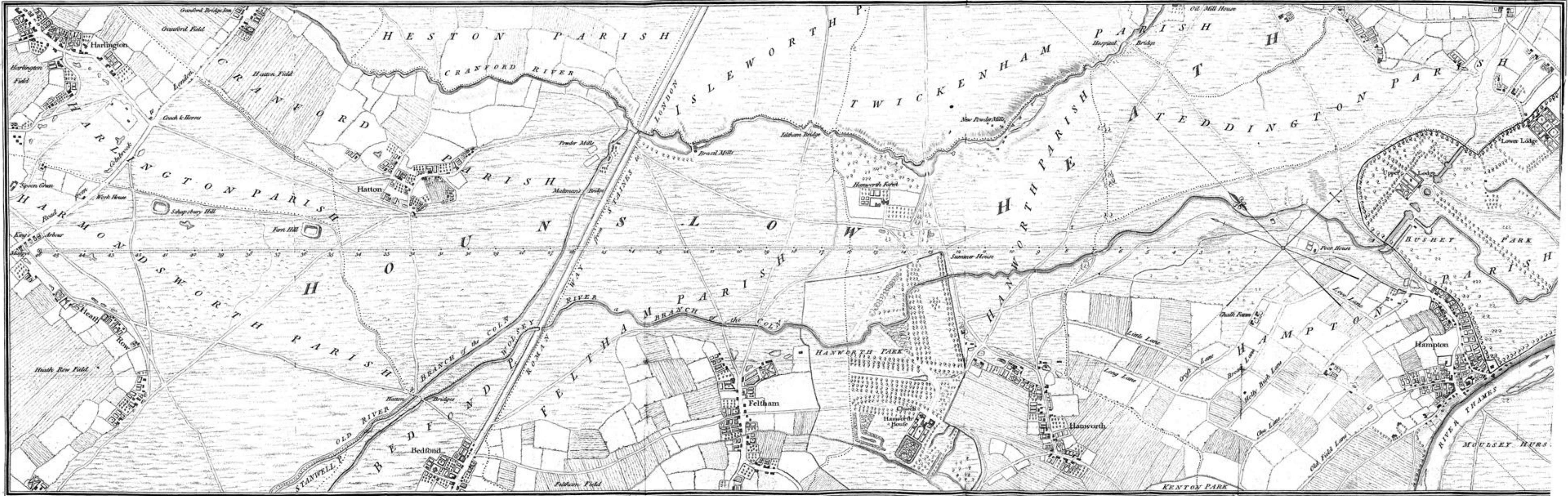

Scale of Two Miles.

Scale of Feet.

Scale of Fathoms & Toises.



For the DESCRIPTION and APPLICATION of the STEEL CHAIN.

Holdfall for the 1st End of the Chain.

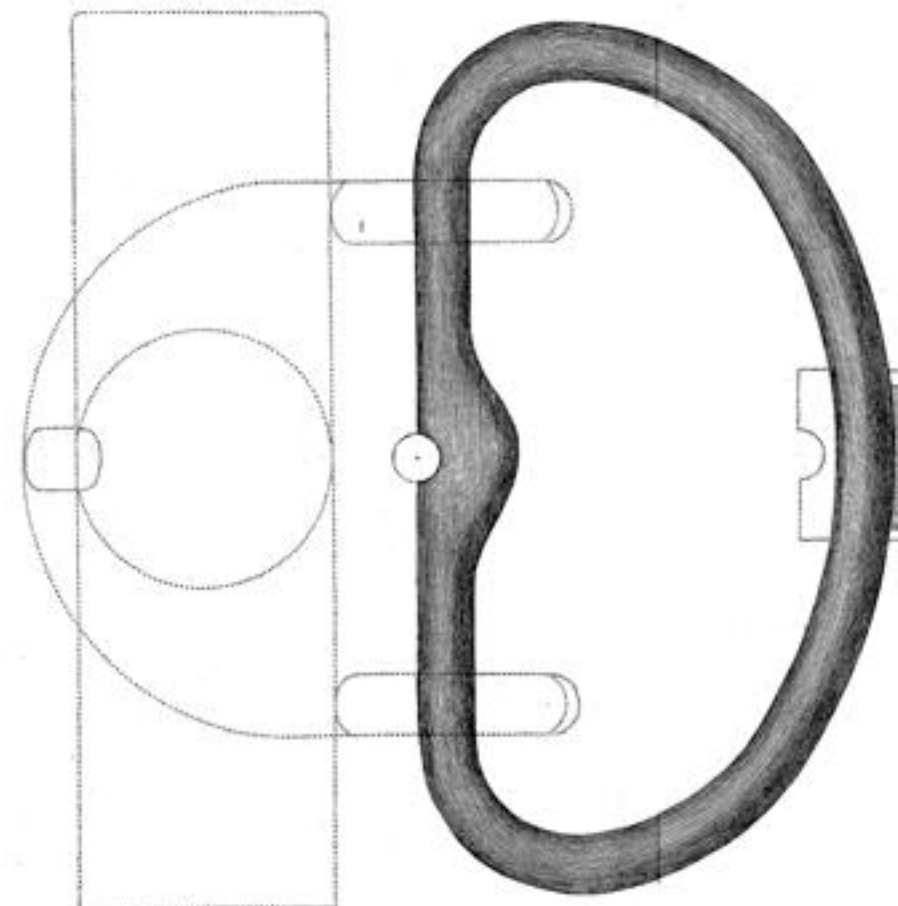

Plan of the 1st Link of the Chain in its original State.

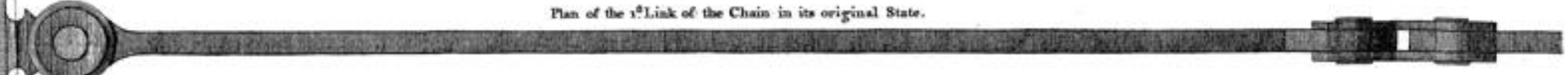

End piece of the 1st Link in its altered State.

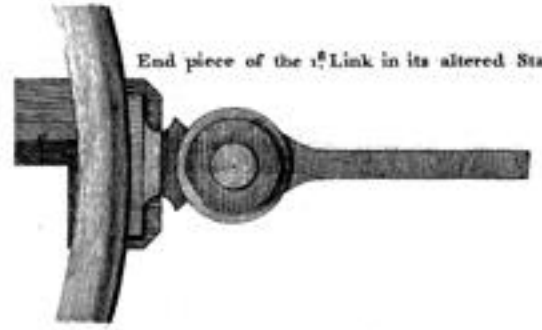

Plan of the Cross joint at every 10th Link.



End piece of the last Link in its altered State.



Elevation of the 1st Link in its original State.

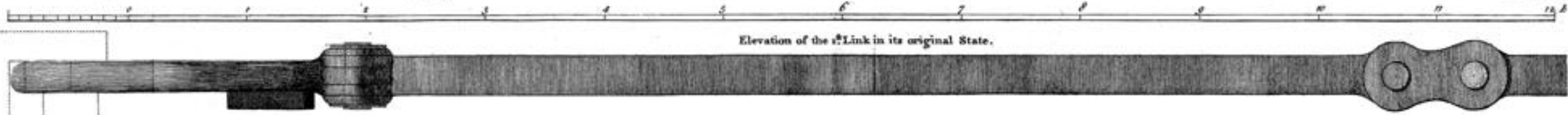

Disposition of Seventeen Stands for the double Measurement with the Chain and Glass Rods.



Top of the Card Stand.

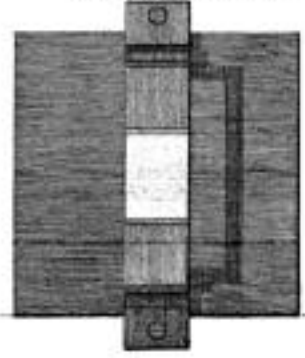

Side Elevation of the Card Stand.



End Elevation of the Card Stand.

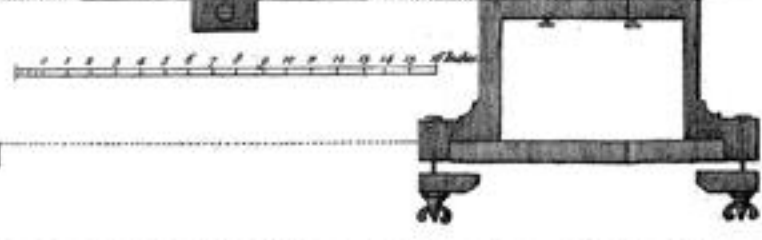

Apparatus for the 1st End of the Chain $\frac{1}{2}$ of the real dimensions.

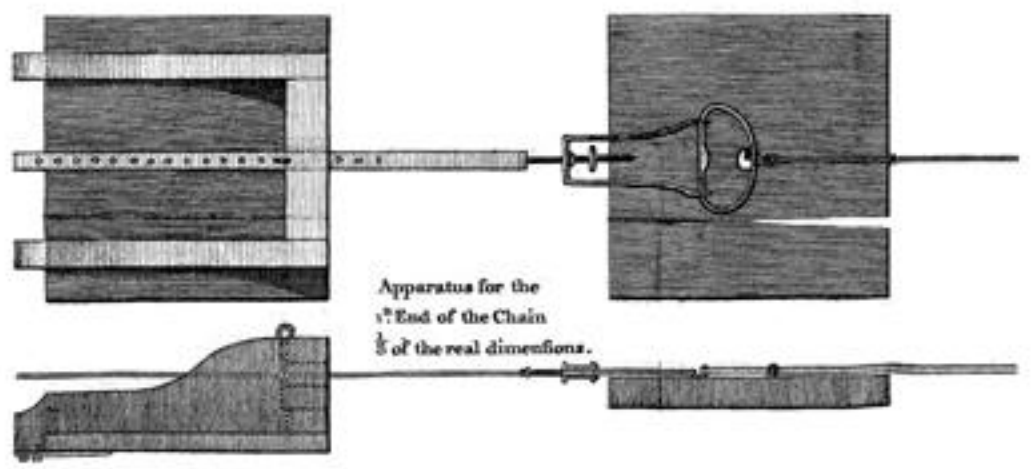

Apparatus for the last End of the Chain.

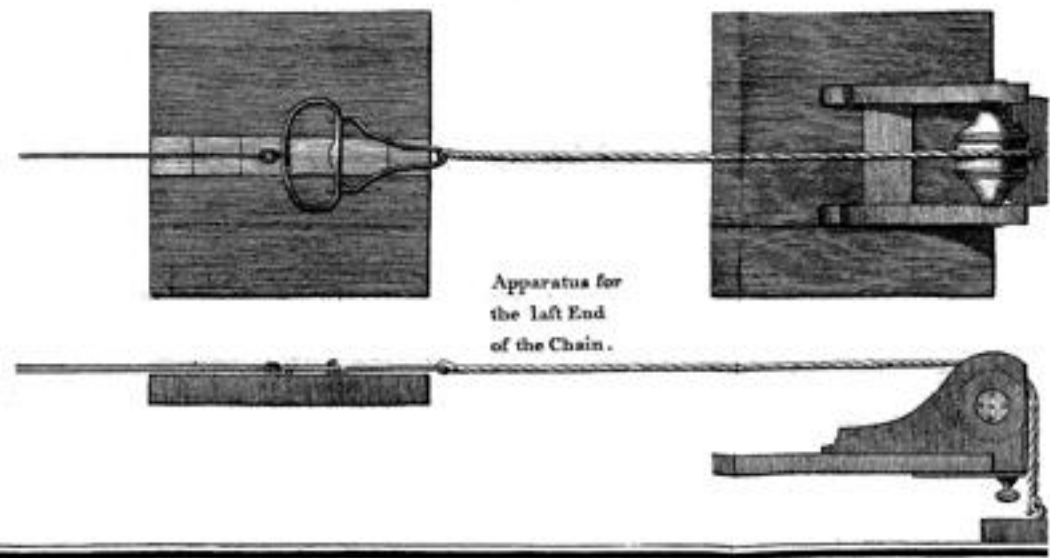

For the DESCRIPTION and APPLICATION of the DEAL RODS &c.

Subdivision of the Ground of one Hypothense of 600 Feet into 30 Rod Lengths, and method of tracing the Line through the Air by means of the Boning Rods.

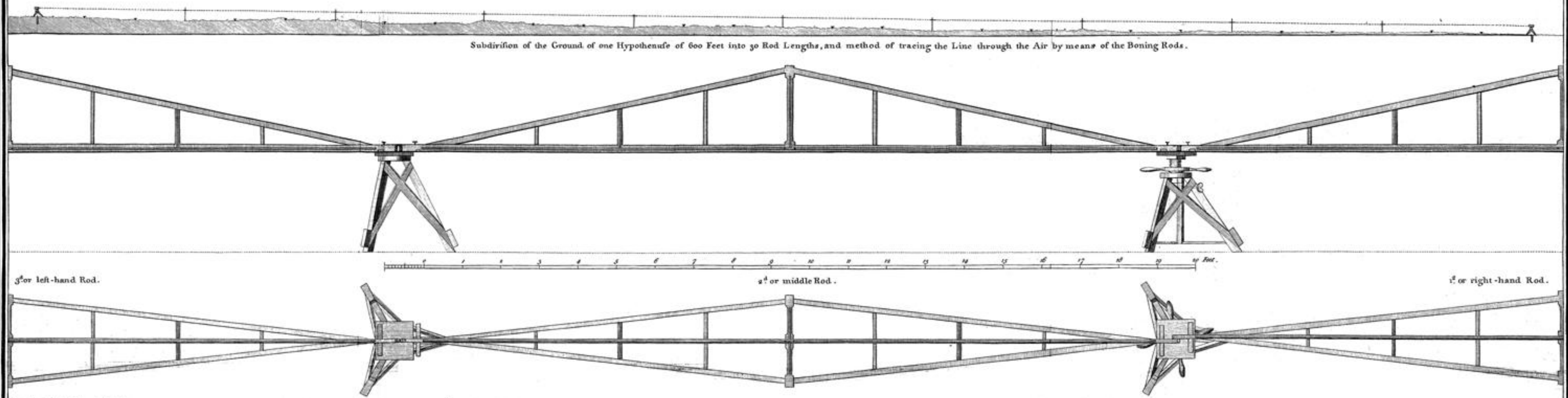

Section of the Pipe & Wheel terminating the Base.

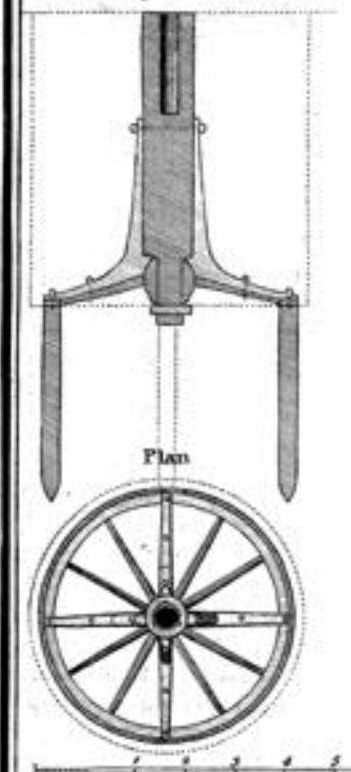

Elevation of the Ends of the Rods in Contact $\frac{1}{4}$ of the real dimensions.

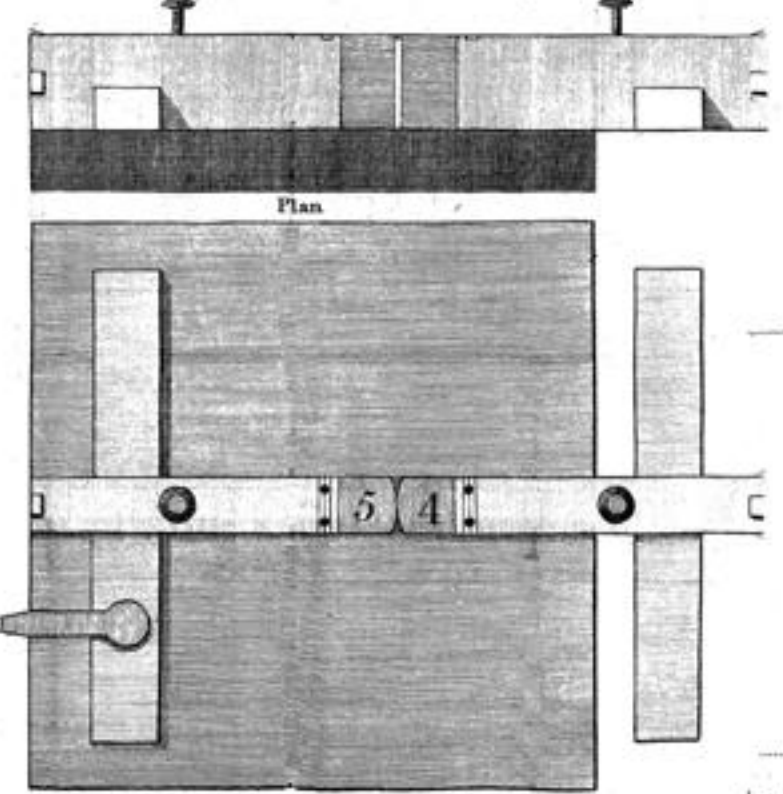

Elevation of the Tripod.

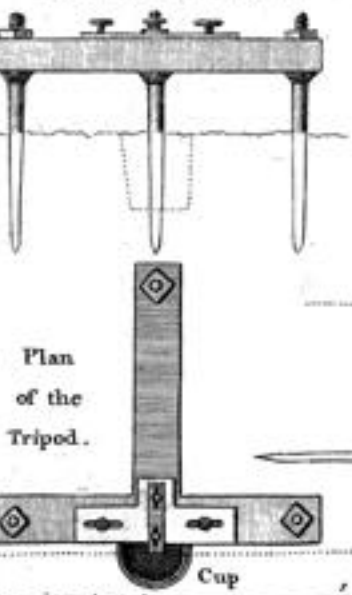

Elevation the Rods seen endwise.

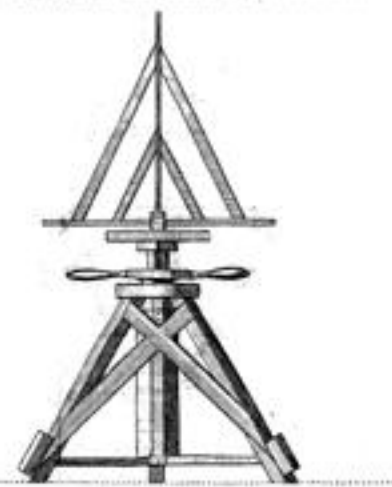

Boning Telescope.



Boning Rod.

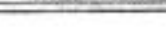

Painted Board.



Horizontal Clamp.



Elevation of the Ends of the Rods in Coincidence.

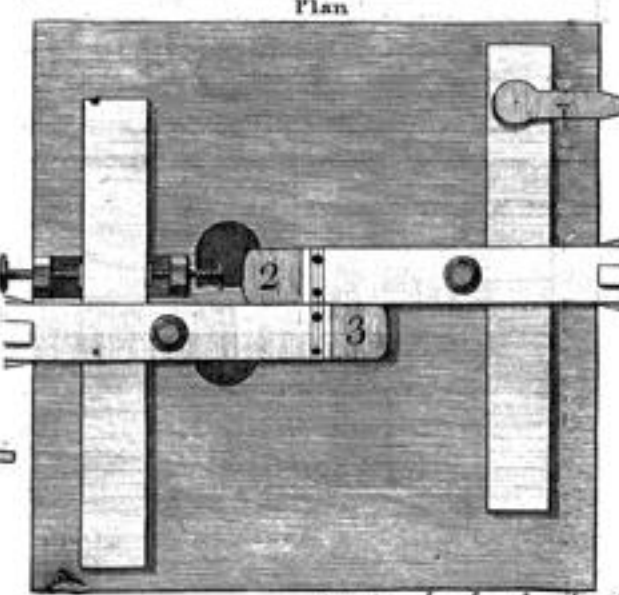
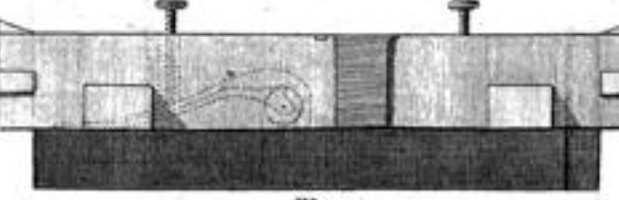

Plan of the Top of the Stand shewing the Grooves for the horizontal Clamp $\frac{1}{4}$ of the real dimensions.

For the DESCRIPTION and APPLICATION of the GLASS RODS.

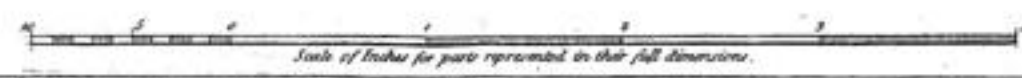
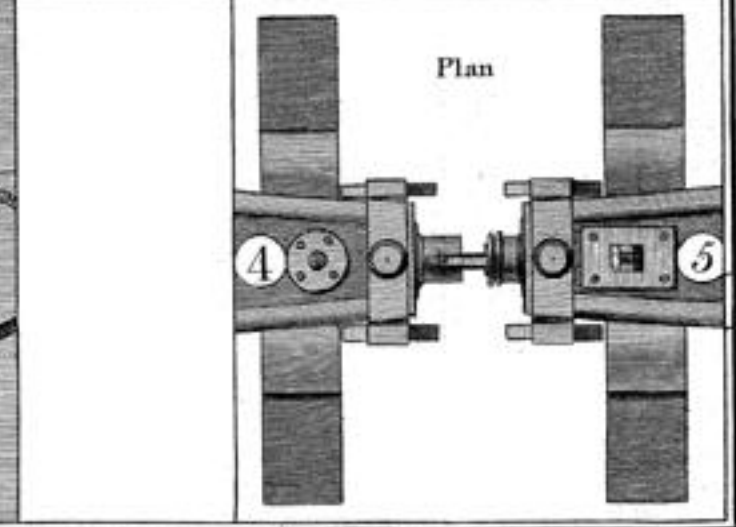
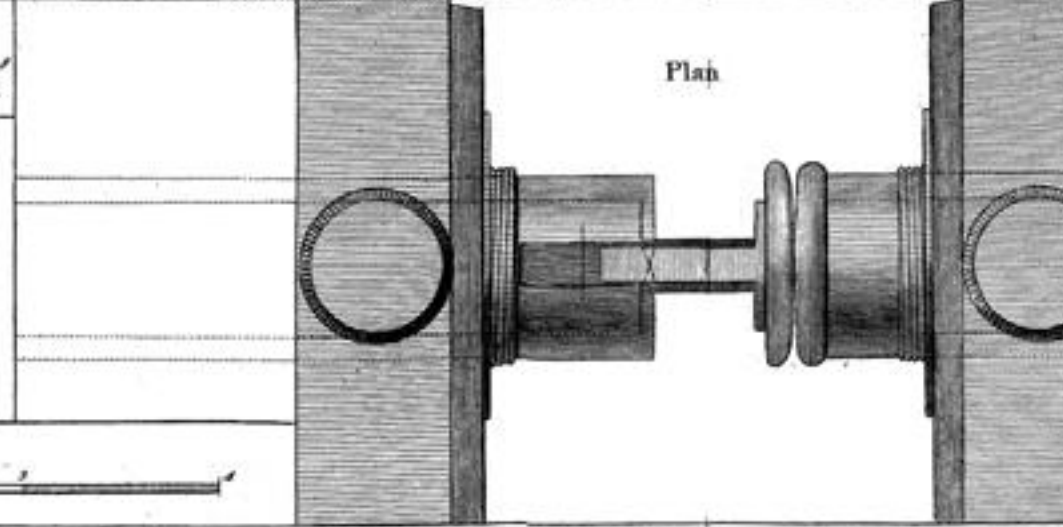
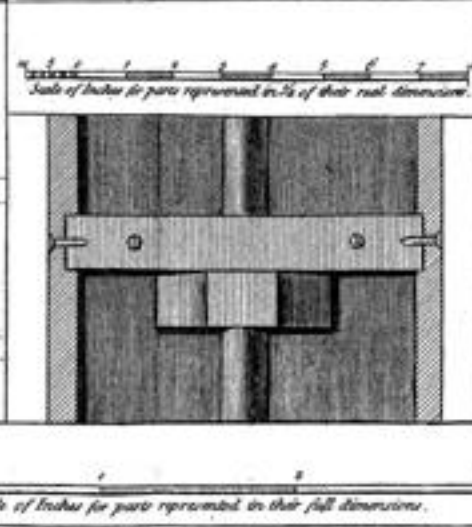
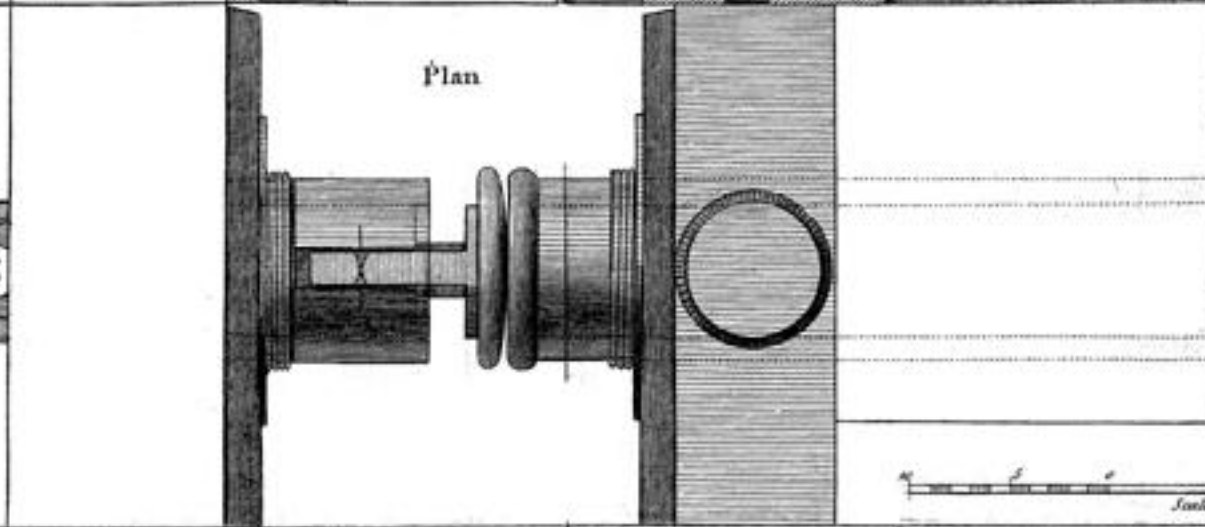
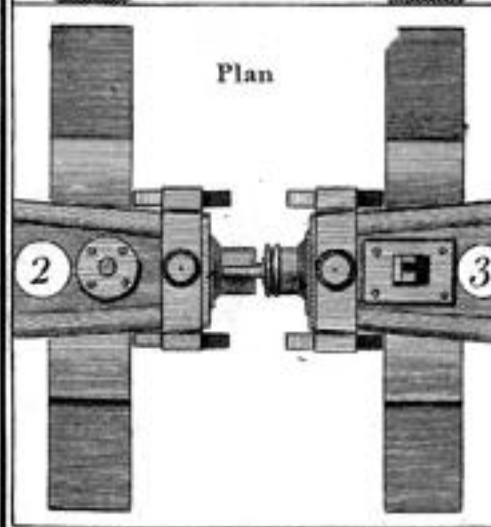
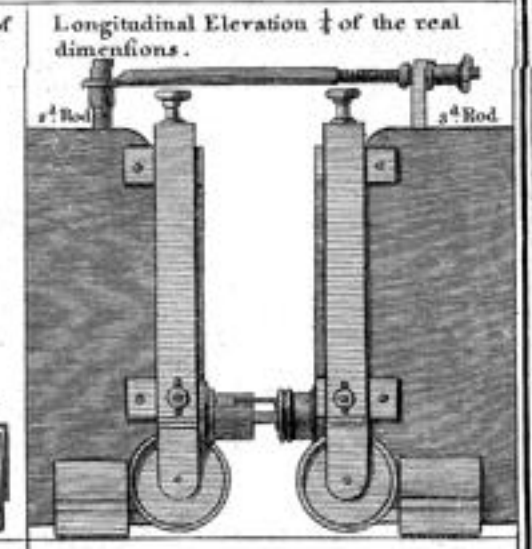
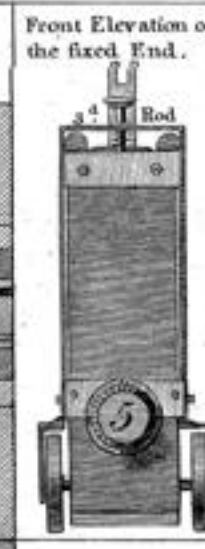
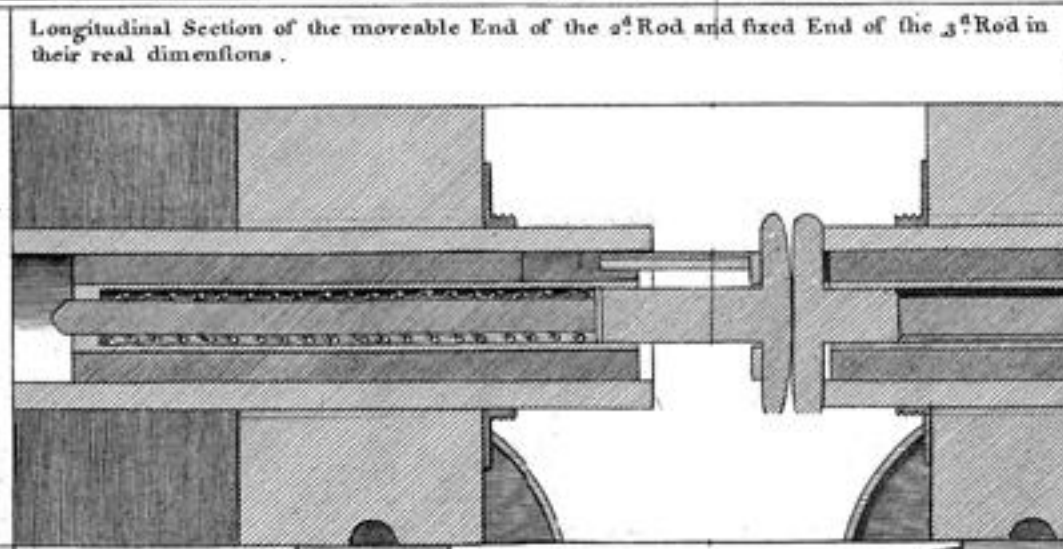
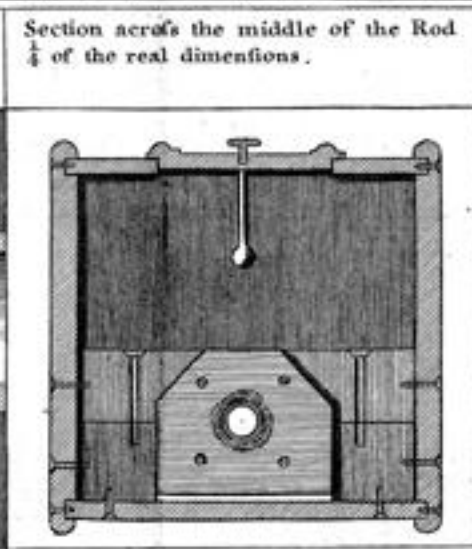
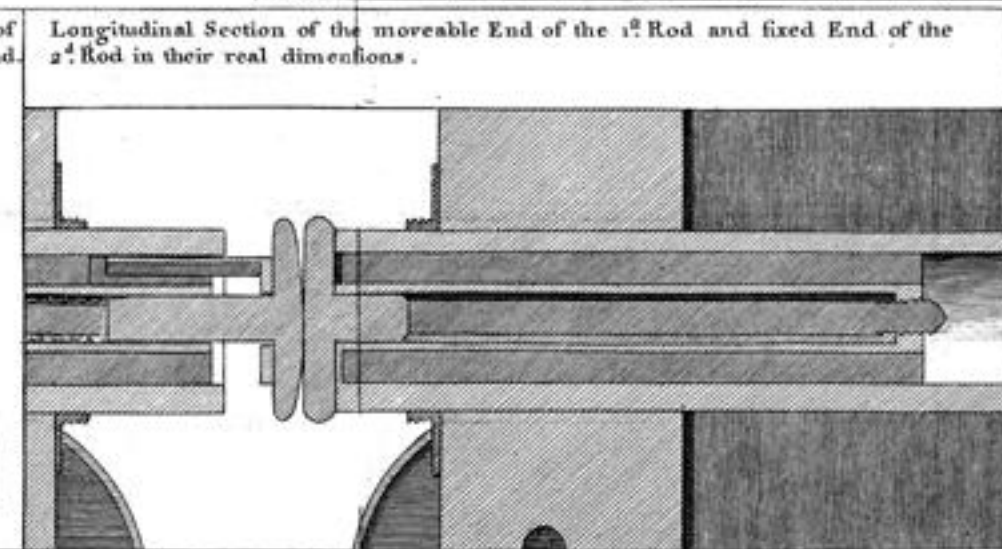
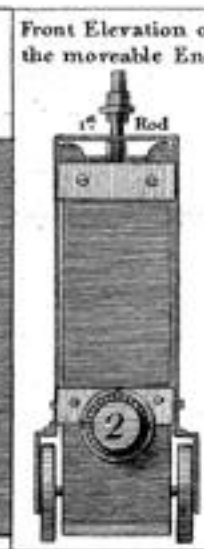
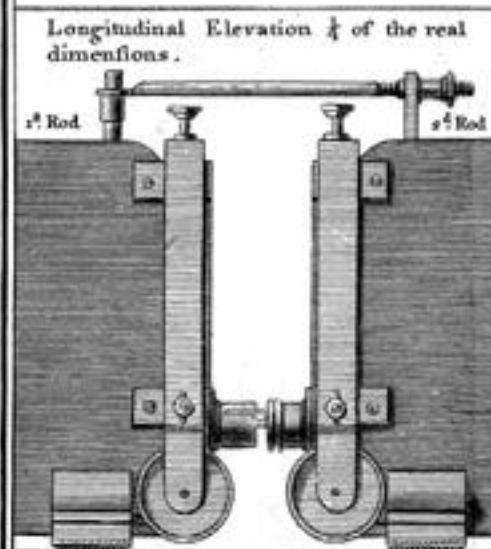
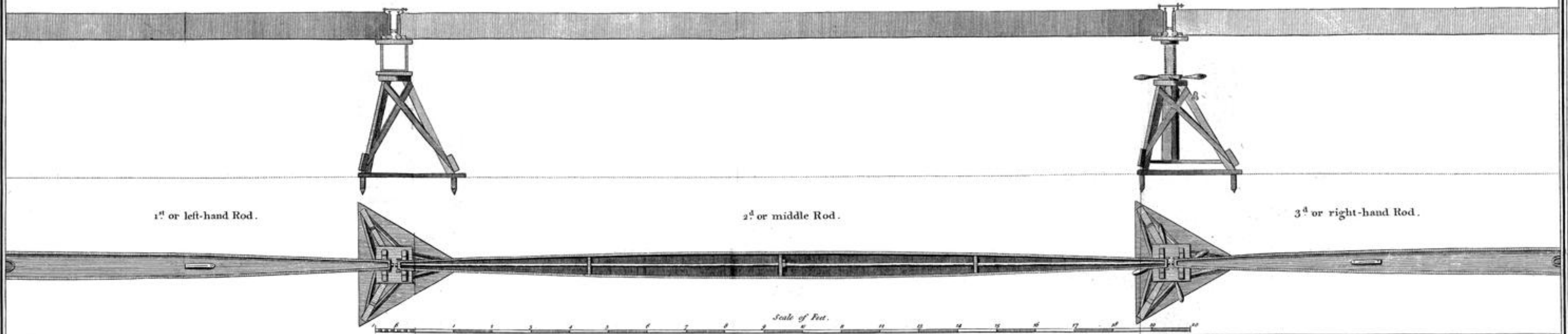

For the DESCRIPTION and USE of the MICROSCOPIC PYROMETER.

CONSTRUCTION of the MICROSCOPES.

Elevation of the Eye Piece Side.

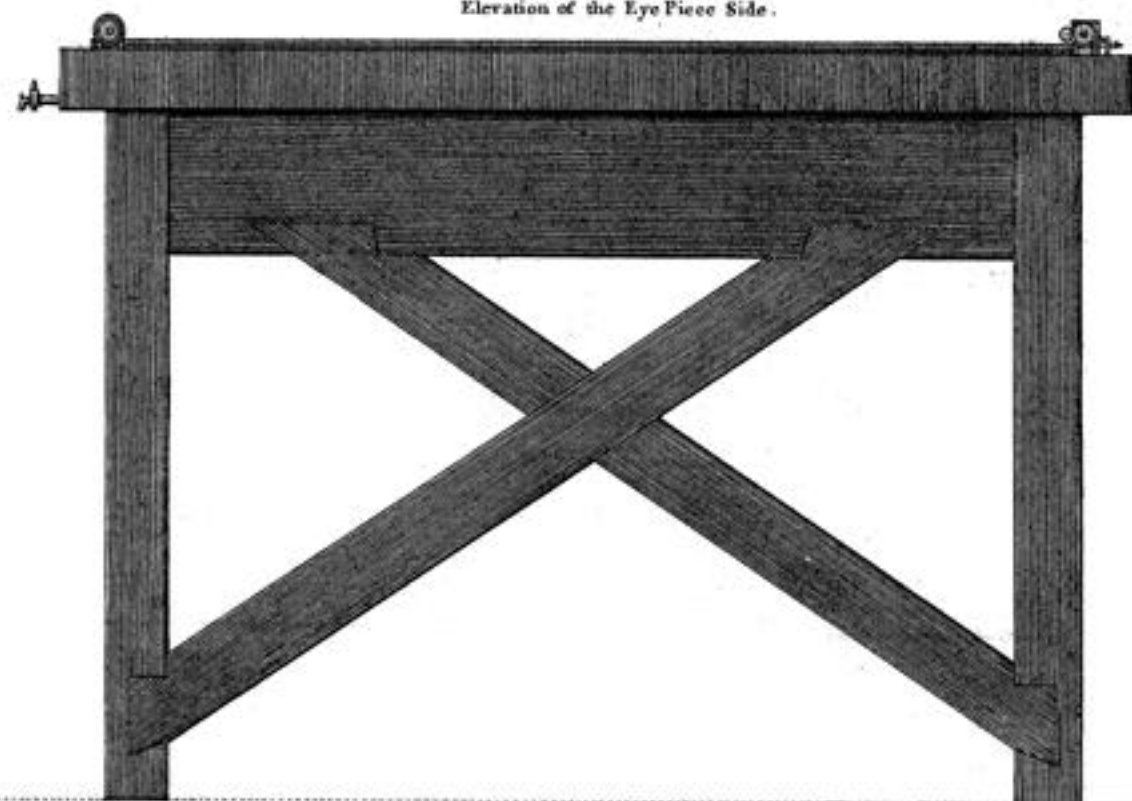

Elevation of the Micrometer End.



Angular View of the fixed End.

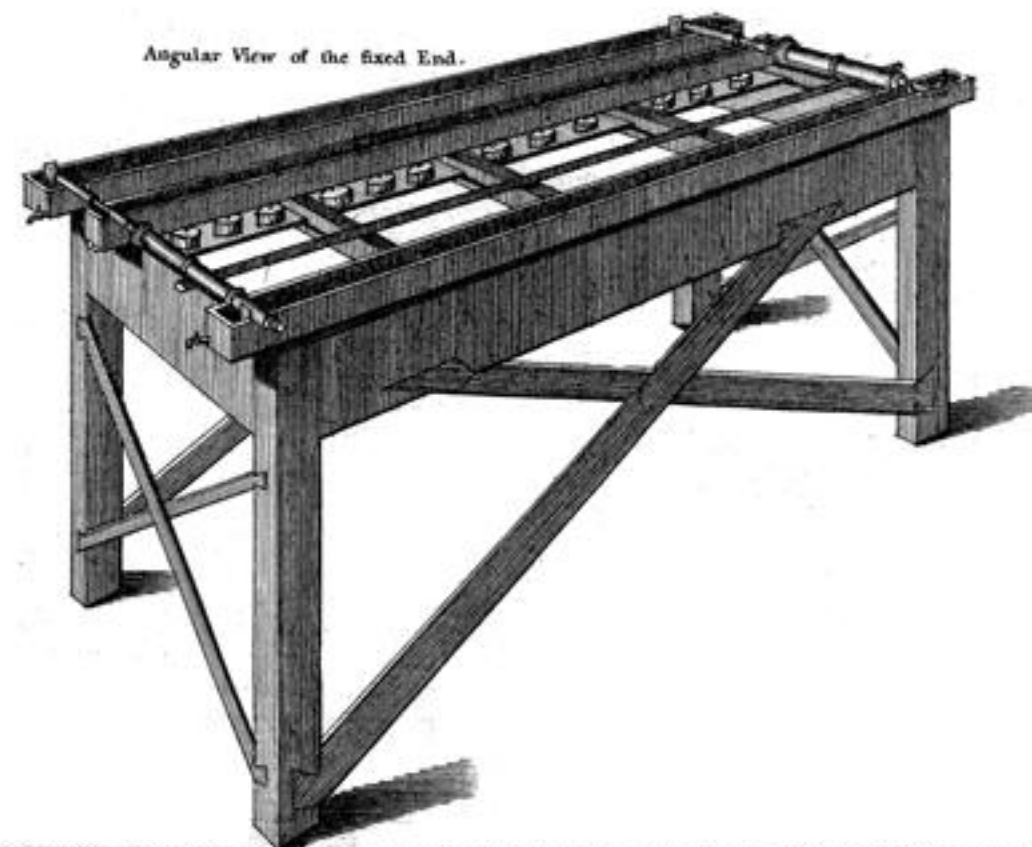

Marks real size of the Apertures.

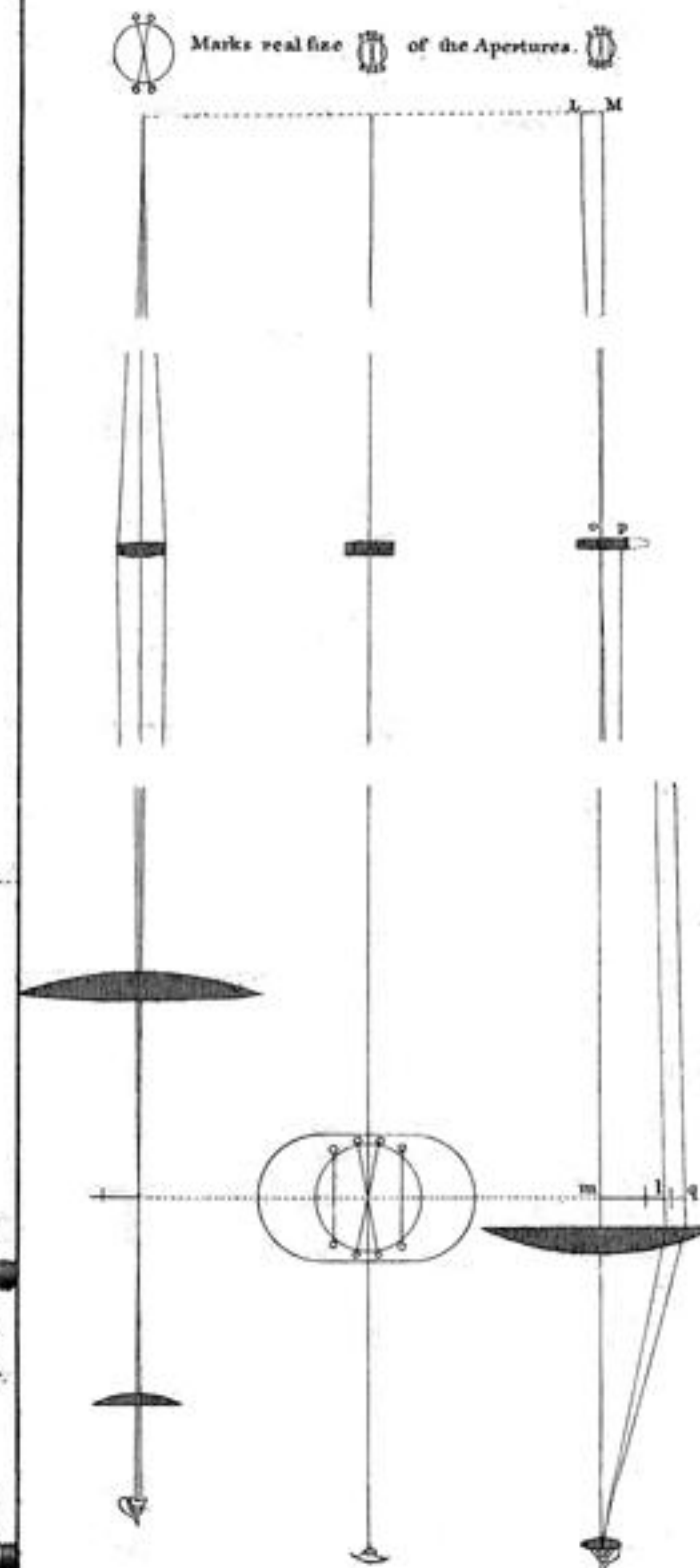

General Plan of the Top.

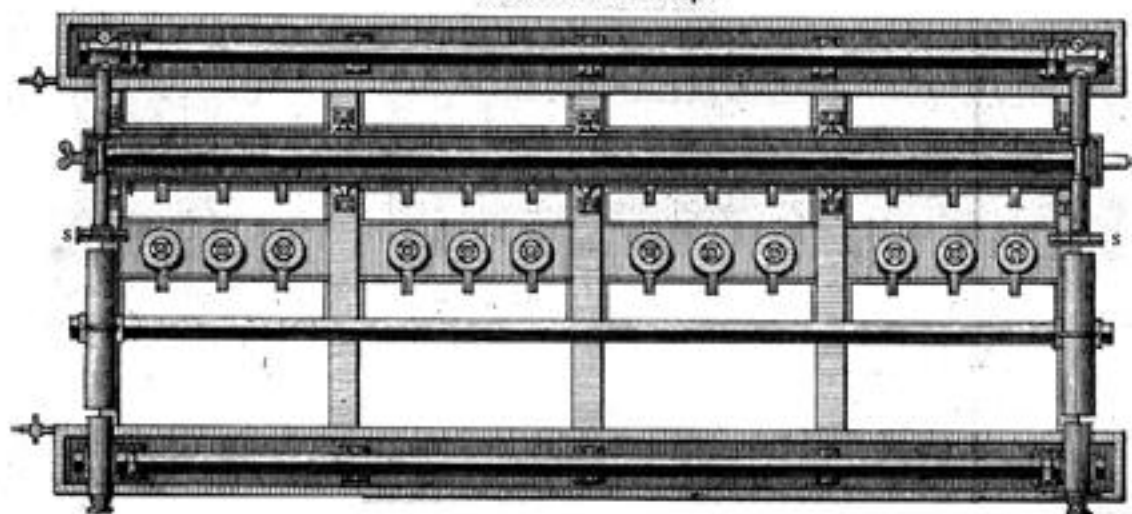

Scale to the General Plan and Elevations.

PLANS and ELEVATIONS of the MARKS and EYE-PIECES 1/4 of the real size.

Fixed Microscope.

Micrometer Microscope.

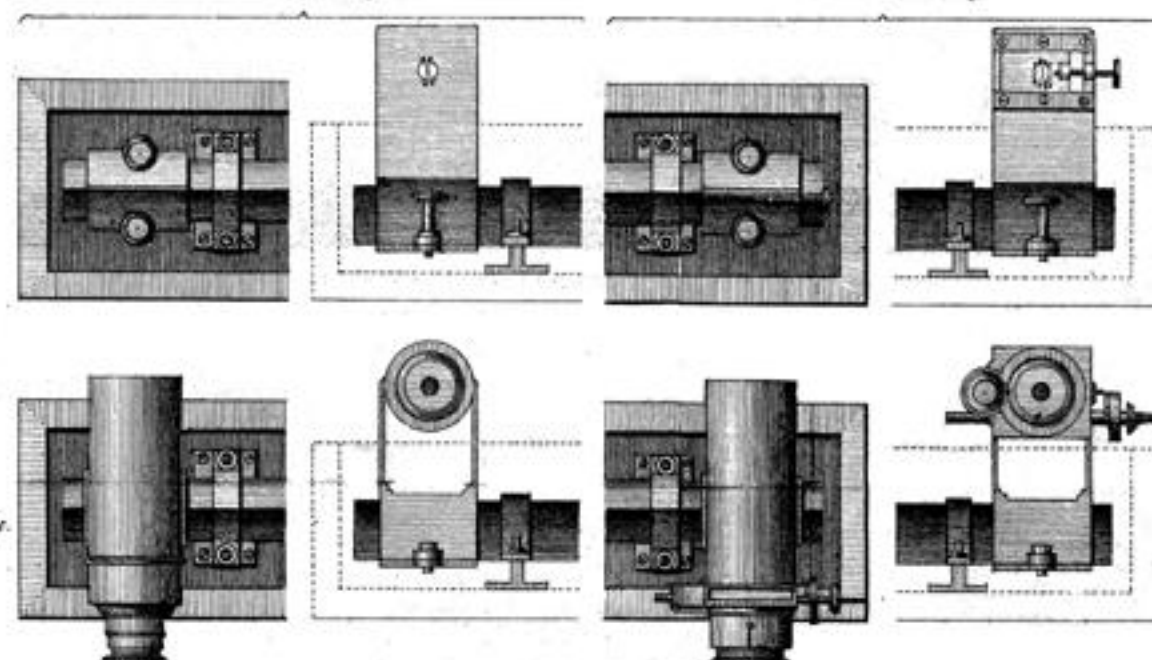

Elevation of the Micrometer full size.

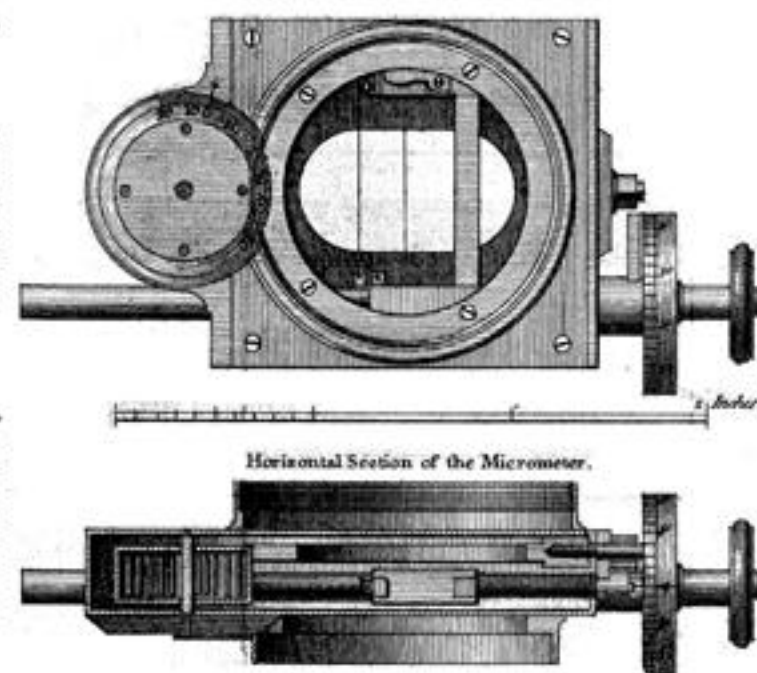

Horizontal Section of the Micrometer.

Elevation of the fixed end of the Boiler.

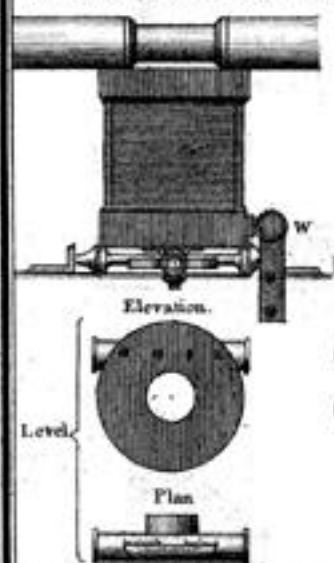

Longitudinal Section of the Boiler with its Slides and the Steel Rod as in experiment 1/4 of the real size

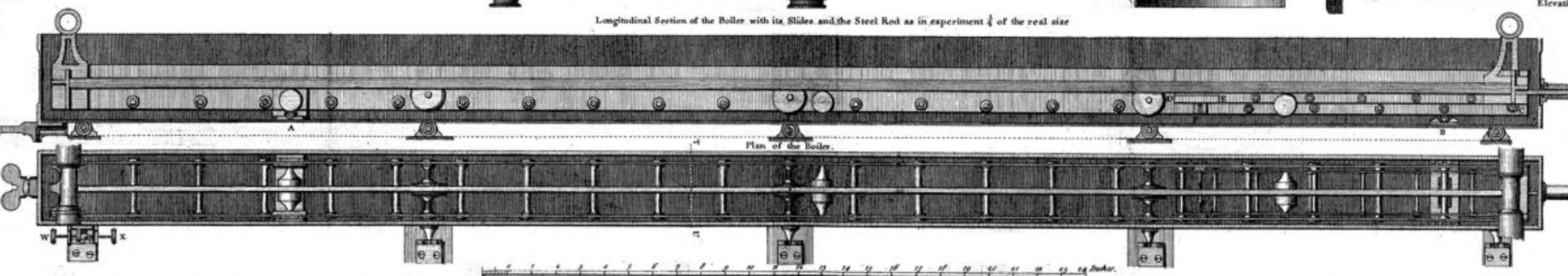

Plan of the Boiler.

Elevation of the Spring End of the Boiler.

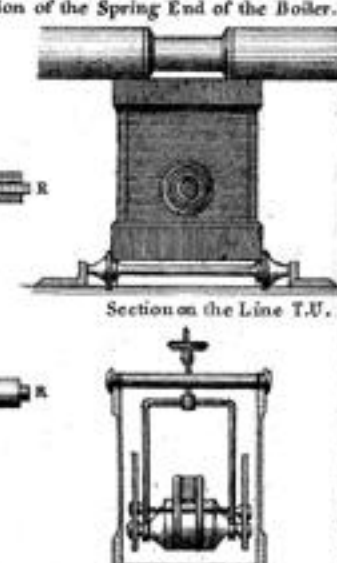

Section on the Line T.U.